

Please Approve this Drawing

Date

Signature

REVISIONS (修正)

NO. (序号)	DESCRIPTION(描述)	ECN NO.(变更号)	DATE(日期)
A.0	NEW RELEASE	ECN-2201607010	2016.08.08

NOTES:

- Materials:
 - .Housing: HTN FR52G30 UL94V-0 Black
 - .Cap: HTN FR52G30 UL94V-0 Black
 - .Pin: brass C3604
- Plating:
 - .Pin: 10 micro-inch minimum Au over
 - 50~100 micro-inch nickel.
- Max processing Temp: 265°C for 10 seconds
- Harmful material control please follow DOC. NO. "DQ03050"

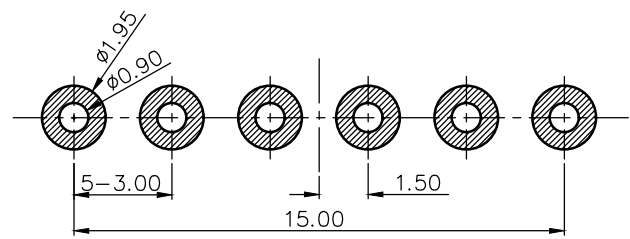
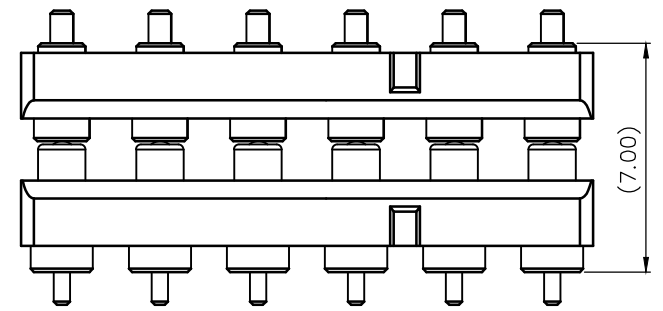
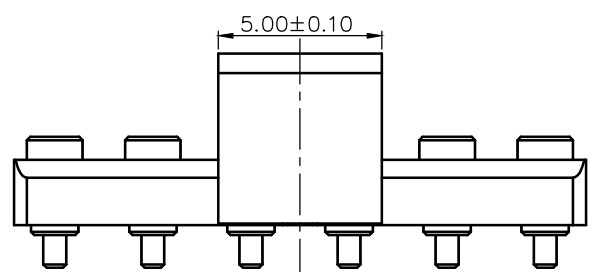
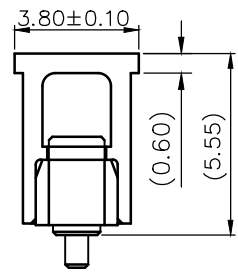
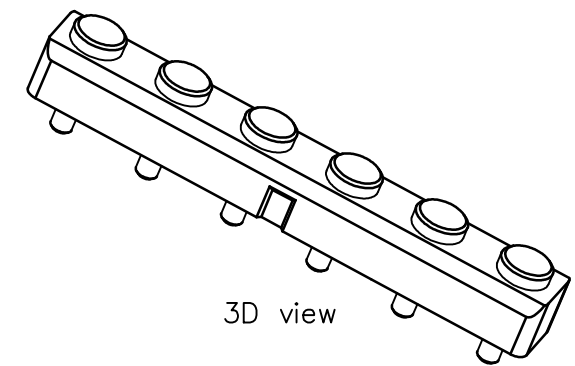
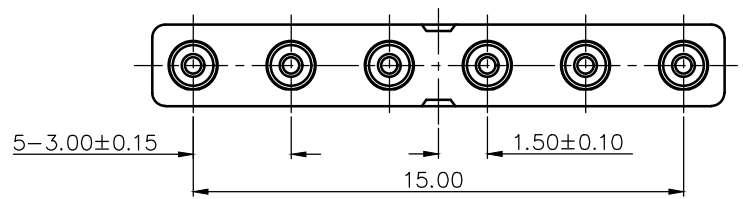
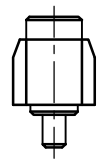
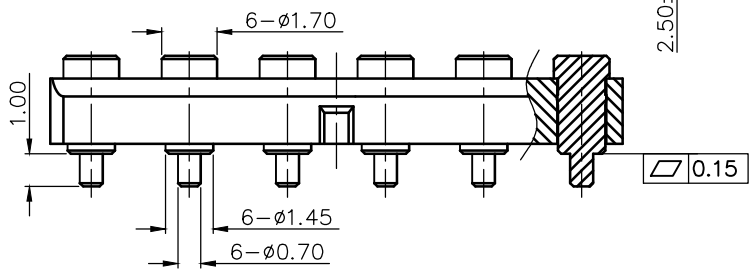
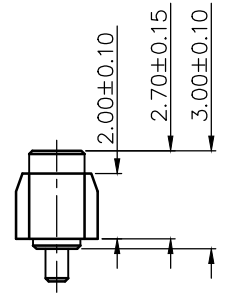
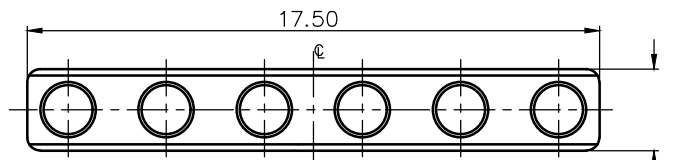

RECOMMEND PCB LAYOUT(TOP VIEW)
Layout Tolerance: ± 0.05mm

DRAW (设计)	Hendy. xiao	SCALE (比例)	10 : 1	UNIT (单位)	mm	DRAWING NO. (图号)	P3588FT02-06B300MR	
CHECK (校对)		SHEET (页数)	1 of 1	PROJECT (视图)		MATERIAL (材质)	Seeing notes (见备注)	
AUDIT (审核)		DATE (日期)	2016.08.08	REV.	A.0	TITLE (品名) 6 pin Female Conn.		
APPROVE (核准)		PLATE (镀层)	Seeing notes (见备注)					

THE UNMARKED TOLERANCE ARE AS BELOW :
(未标记的公差)

LENGTH (尺寸)		ANGLE (角度)	
0~6.0	±0.05mm	0.	±2.0°
>6~30	±0.10mm	0.0	±1.0°
>30~120	±0.15mm	0.00	±0.50°

C.C.P. (DG) CONTACT PROBES CO.,LTD.
东莞中探探针有限公司

The information in this document is property of C.C.P company and should not be copied or reproduced in any other way, without written permission.