

CCP DRAWING NO: **FCSC-100250-2100**
(Φ 10mm crown spring)

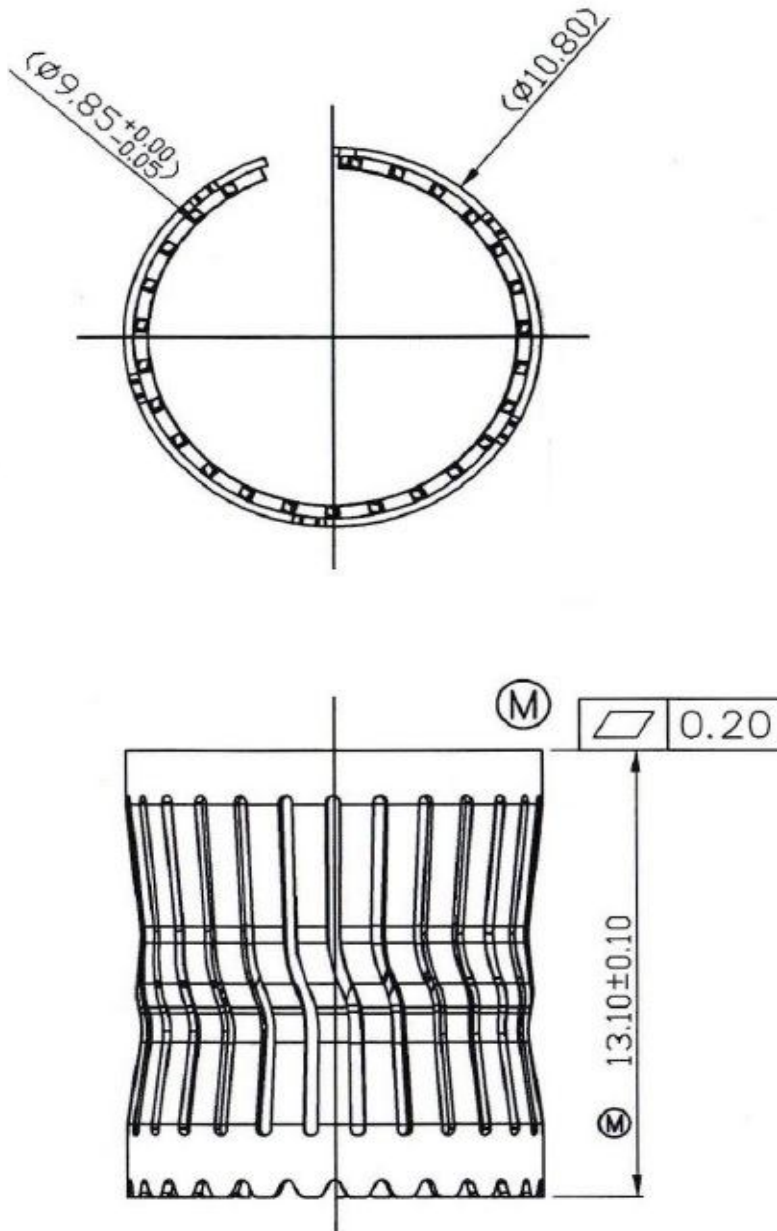

Note (technical specification):

1. Material: Be-cu 11-SHC, T=0.20mm Hardness: HV 280-330.
2. Plating: Nickel bottom 50-100u", Silver plating 80-200u".