

CCP DRAWING NO: **FSSC-028000-0000**

(Φ 2.8mm crown spring)

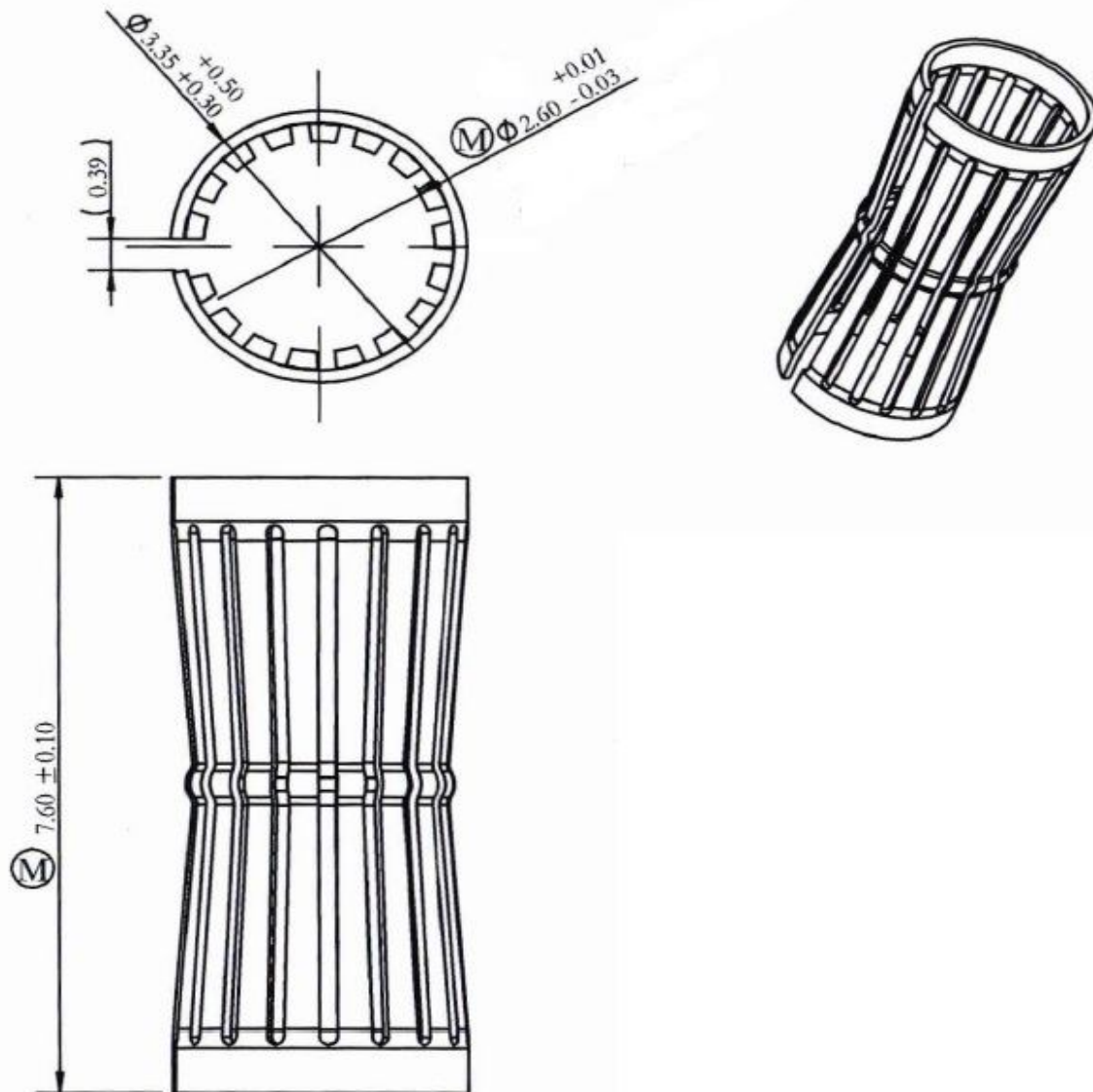

Note (technical specification):

1. Material: C17200 1 / 2H, T=0.15mm

Hardness after heat treatment: HV 380-420.

2. Plating: Nickel bottom 80u "Min, Silver plating 200-320u".