



CCP Contact Probes

POGO PIN CONNECTOR



CCP Contact Probes - Product Applications



Wearable Devices

TWS / Smart Watch /
VR/AR Headset

Pogo Pin Connector
Charging Cable
Charging Case
Housing



Charging Stations

Smart Home / Tablet /
POS System

Pogo Pin Connector
Charging Dock
Charging Cable



Healthcare Devices

Brain Wave Headset /
Hearing Aids

Pogo Pin Connector
Charging Case
Charging Cable
Waterproof USB Type-C



Electric Vehicle

EV Charging Station / Battery
System / E-Bike Connector

Crown Spring Terminal
Charging Gun
Battery Connector
E-Bike Connector



CCP Contact Probes - History

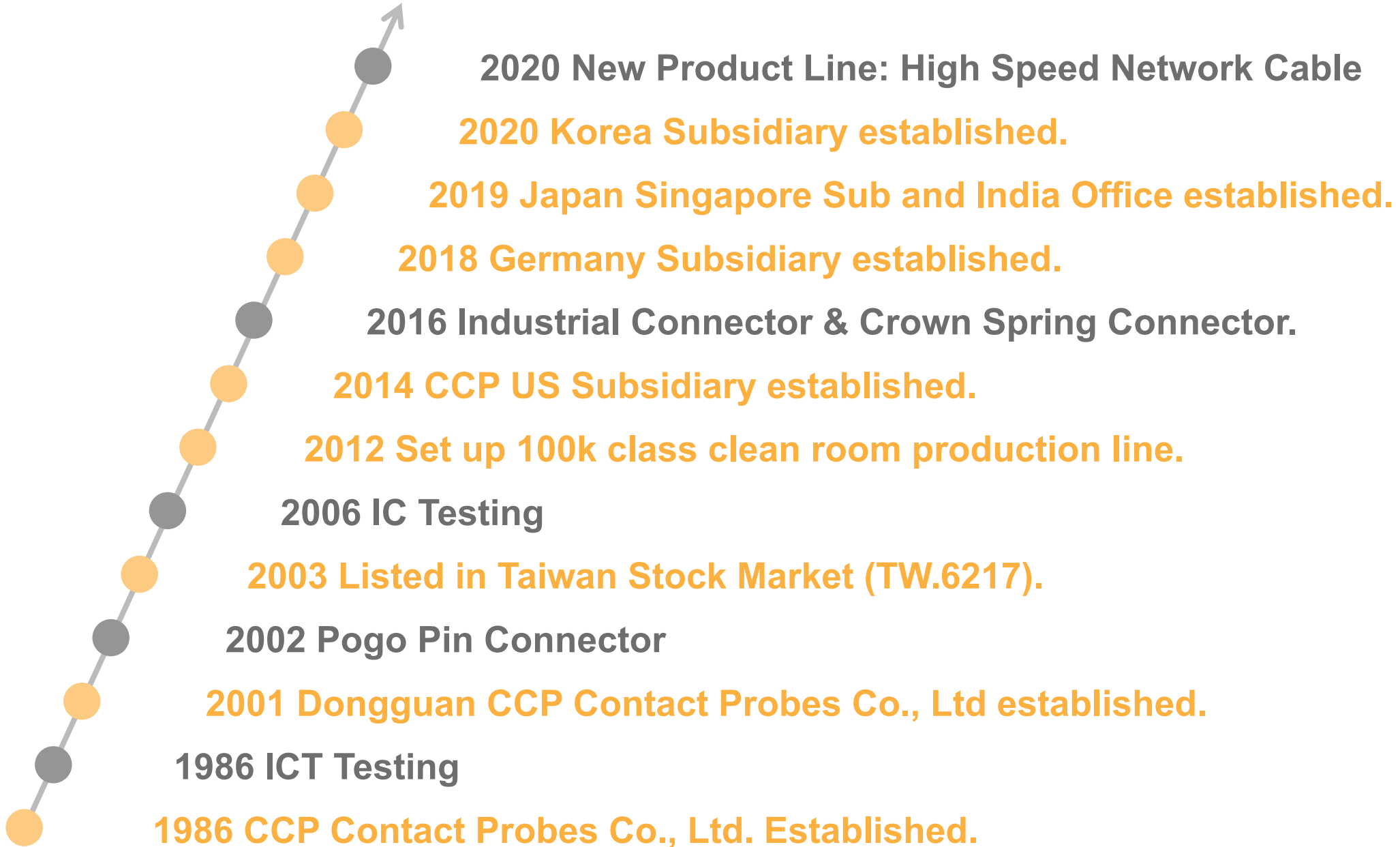



CCP Contact Probes - Growth



#1 in Consumer Product Market

Collaborate with Top 10 the World's Most Valuable Brands

Over 1000% Growth in the Past 15 Years

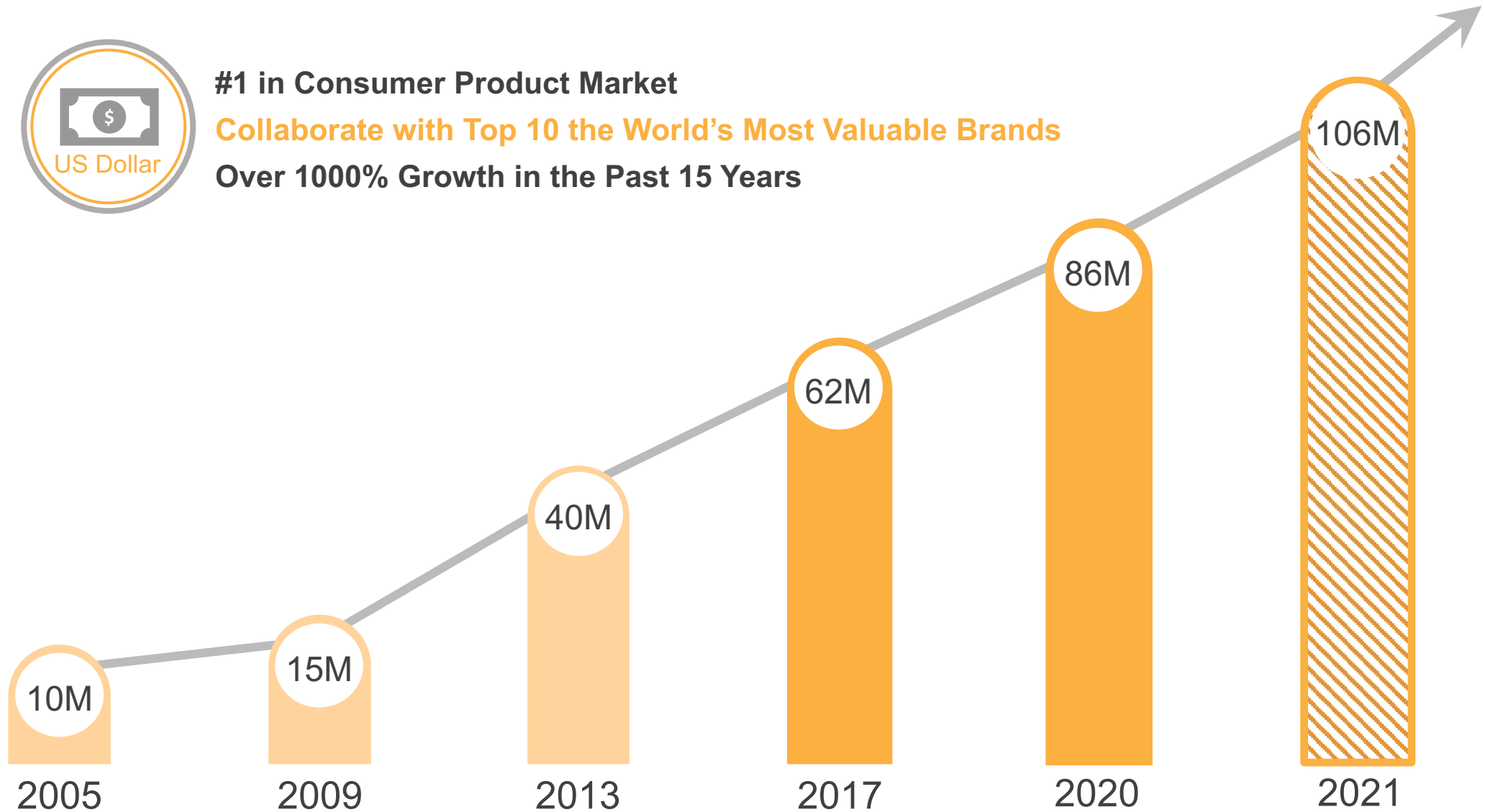



CCP Contact Probes - Worldwide

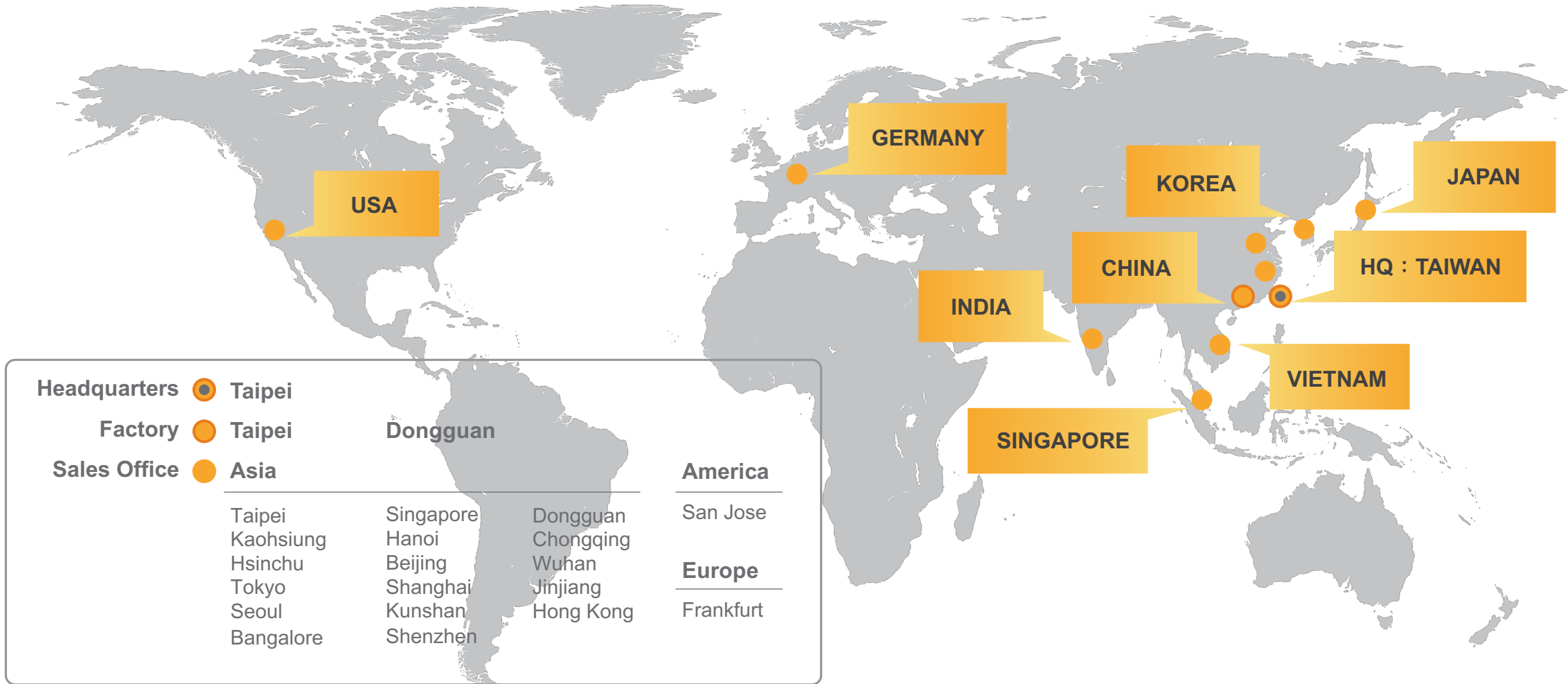

Google

amazon

ADVANTEST

flex



FOXCONN



CCP Contact Probes - Product Portfolio

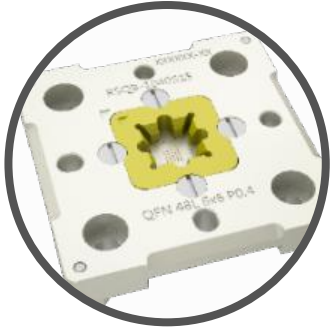

Testing Solution

Fine Pitch

IC Testing Probe
PCB Testing Probe
Testing Socket



Pogo Pin Connector

1A~13A

Pogo Pin Conn.
Waterproof Conn.
Magnetic Conn.



High Current Connector

13A~250A

Electronic Vehicle
High Current Conn.



Medical Connector

Environmental Sensitivity

Circular Conn.
Endoscope Conn.

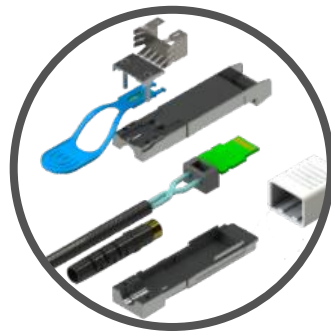

High Speed Cable

25Gbps~100Gbps

Server
Switch
Telecom



Industrial Solution

Extreme Environment

Aerospace
Military
Transportation



CCP Contact Probes – Pogo Pin Advantages



#1 in Consumer Product Market

Collaborate with Top 10 the World's Most Valuable Brands



Innovate to Market Leadership

R&D Team with 30+ Years of Experience
Vertically Integrated Production



Industry Leading Electroplating Technology

Self-Owned Electroplating Plant
Anti-Corrosion Solution For All Kinds Wearable Device
Customized Colors For Customers' Products Design





Pogo Pin Connector Product Line



TWS Earbuds



AR/VR Headset



Smart Doorbell



Smart Watch



2 in 1 Tablet & Stylus



E-Cigarette





Pogo Pin Connector Product Line

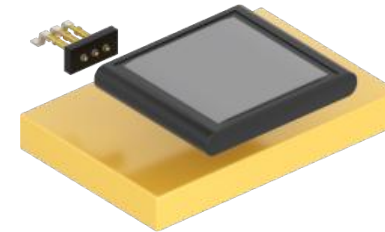
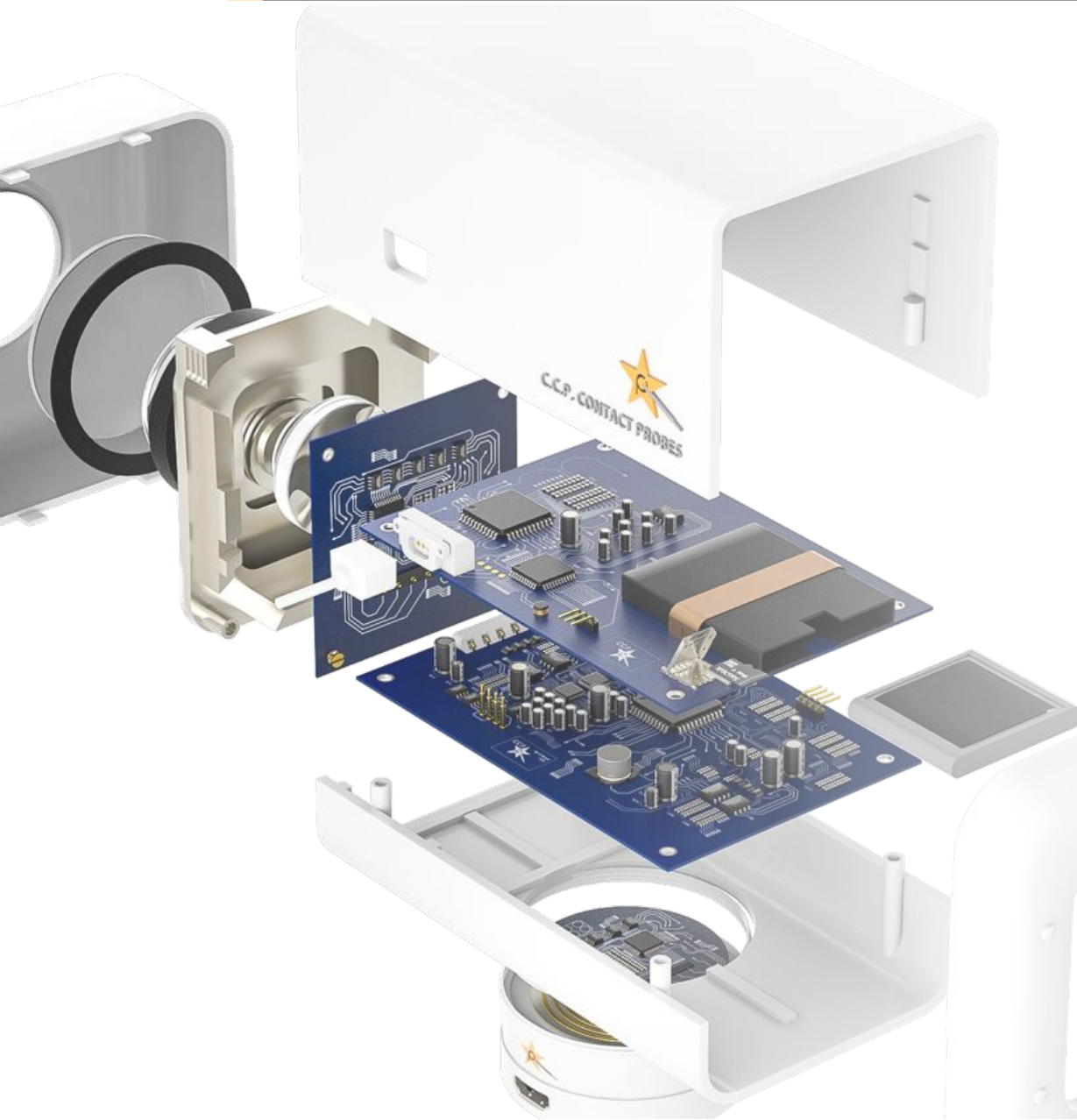

Battery Connector



Waterproof / Magnetic Charging Module

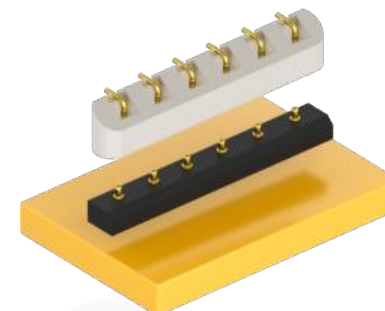

High Frequency Connector

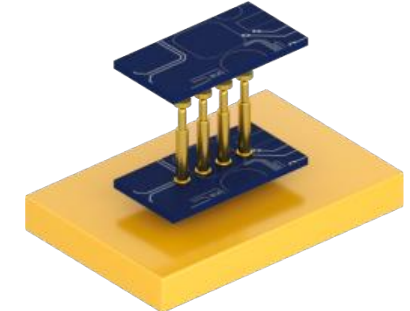

Board to Board Connector

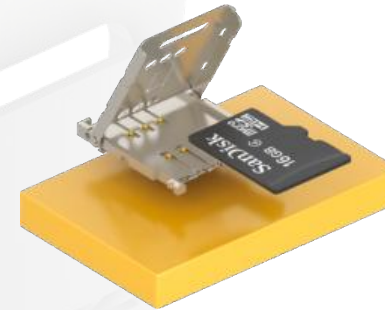

Ultra Small Pogo Pin

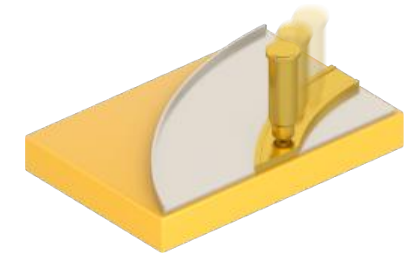

Sliding Connector



Pogo Pin Connector - Basic Structure

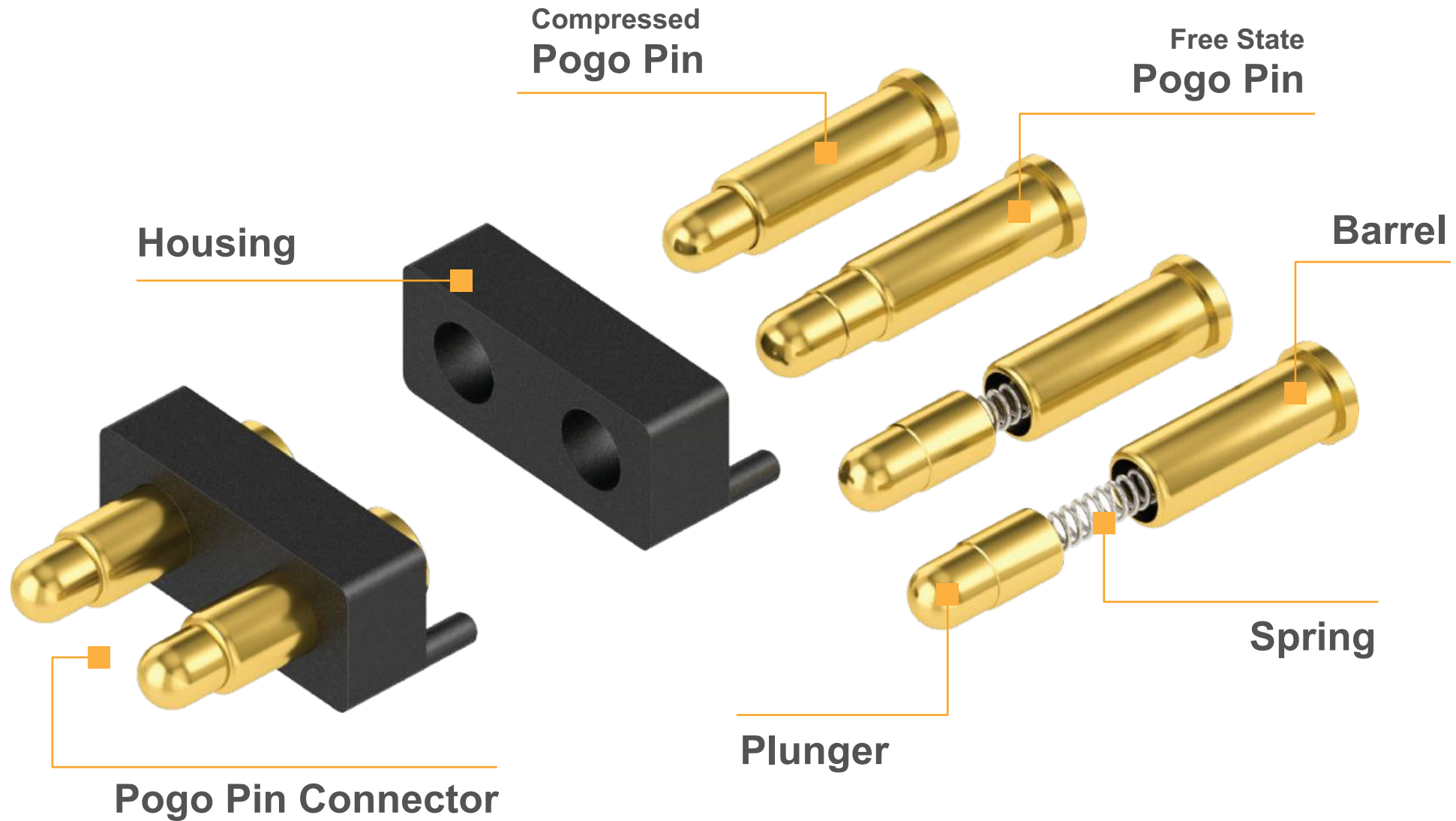



Pogo Pin Connector - Material & Plating Options

Ball

Stainless Steel

Plunger

Brass (Standard)
Beryllium Copper
Phosphor Bronze
SK4

Surface Plating
Base Plating
Base

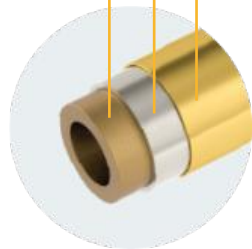

Color Options

PdNi 10u" over Ni 100u" (Silver)
Ru 10u" over Ni 100u" (Black)



Housing

Polyoxyethylen (Standard)
PBT Polybutylene Terephthalate
LCP Liquid-Crystal Polymers
HTN Polyphthalamide
PA10T

Barrel

Brass (Standard)
Beryllium Copper
Phosphor Bronze

Spring

Stainless Steel

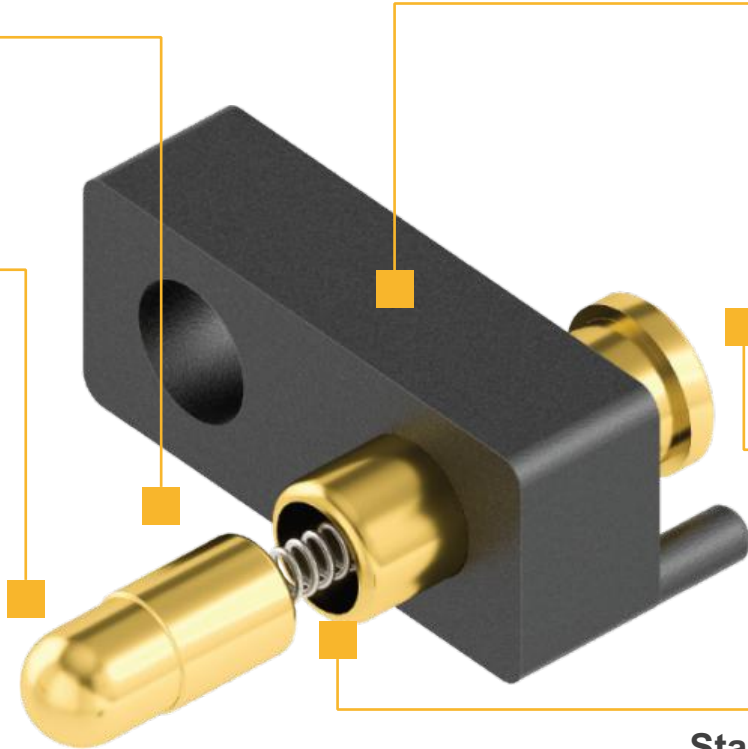



Pogo Pin Connector - Basic Inner Structures

Back Drill

The drilled tail makes extra space for spring and creates a shorter pogo pin.

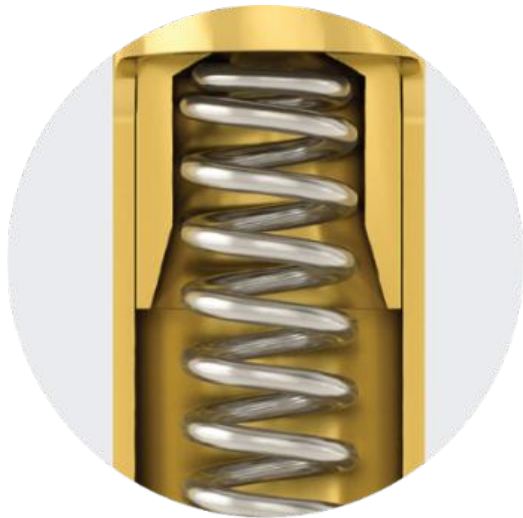

Pin Length: ≈ 2.5 mm
Current: **1 A**

Bias Tail

The bias tail of plunger creates lateral force and better contact.

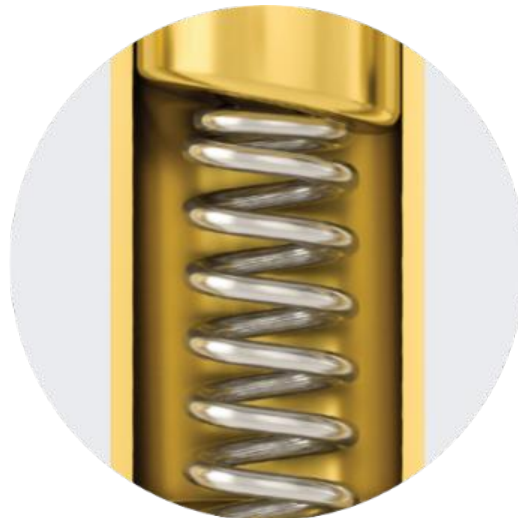

Pin Length: ≈ 3.5 mm
Current: **2 A**

Ball

The ball inside stabilizes the contacting areas for a better performance.



Pin Length: ≈ 4.5 mm
Current: **3~5 A**



Pogo Pin Connector - Waterproof Pogo Pin Connector

Sealing



Pitch: **Small**
Waterproof: **IPx7 at best**
Production Complexity: **Low**

Insert-Molding



Pitch: **Small**
Waterproof: **IPx7 at best**
Production Complexity: **Low**

O-Ring



Pitch: **Large**
Waterproof: **IPx8 at best**
Production Complexity: **High**



Pogo Pin Connector - Waterproof Application



Assembly & glue module

- IPX7
- Electrolytic resistant design

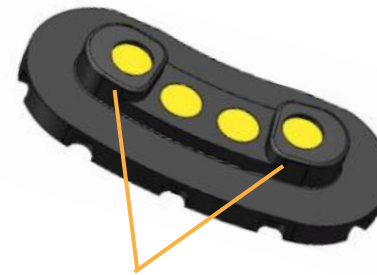

Electrolytic resistant design

- Steps feature on housing

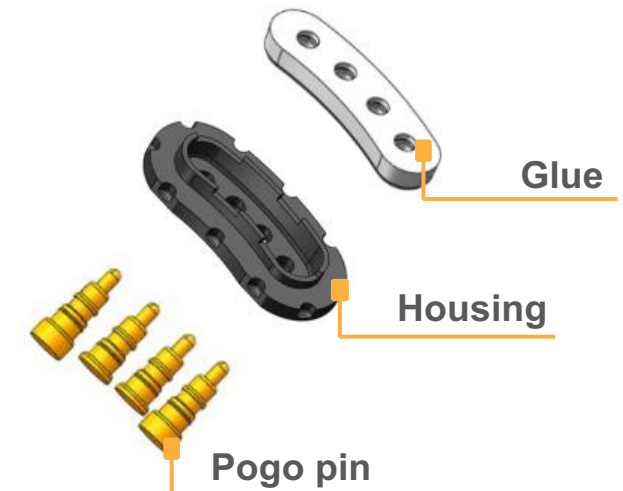



Pogo Pin Connector - Magnetic Connector

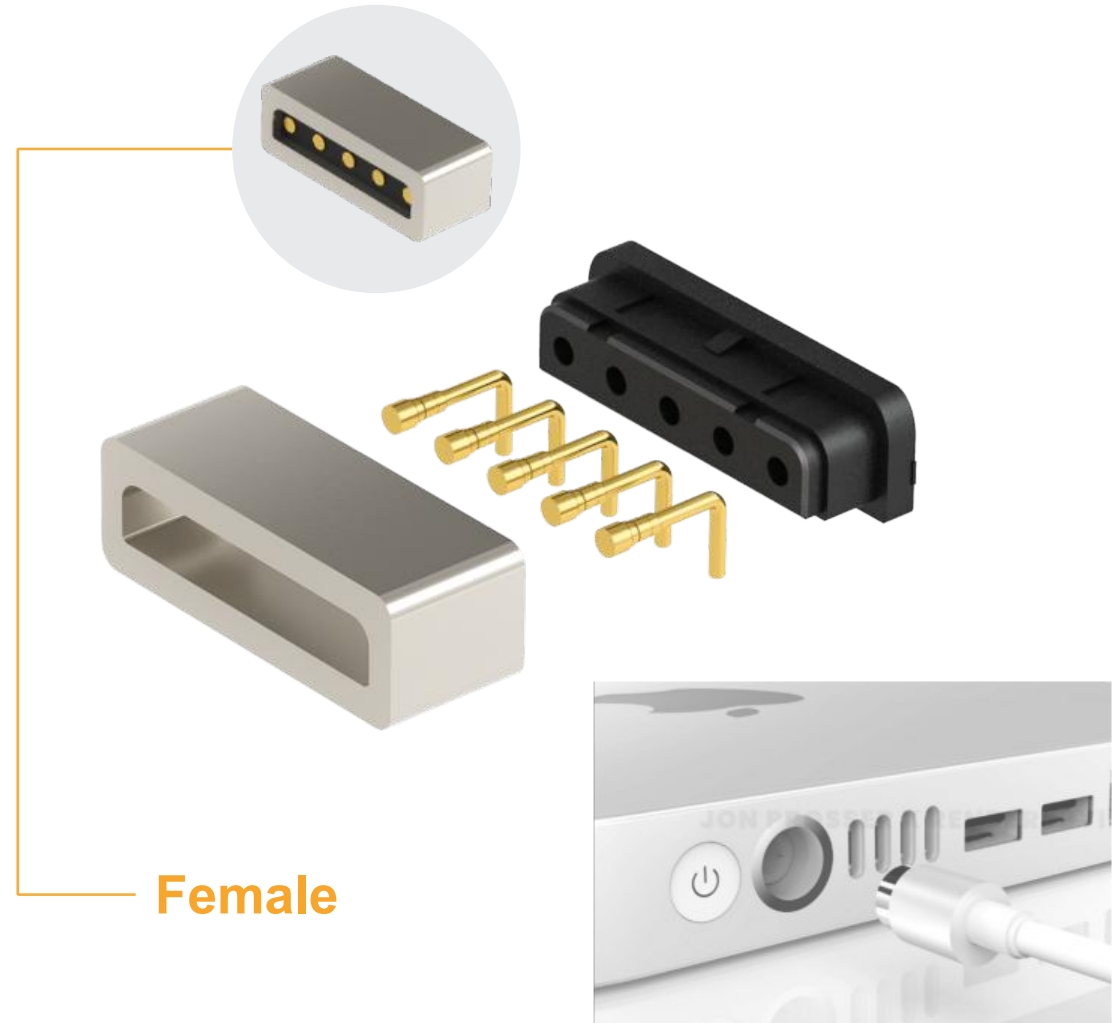
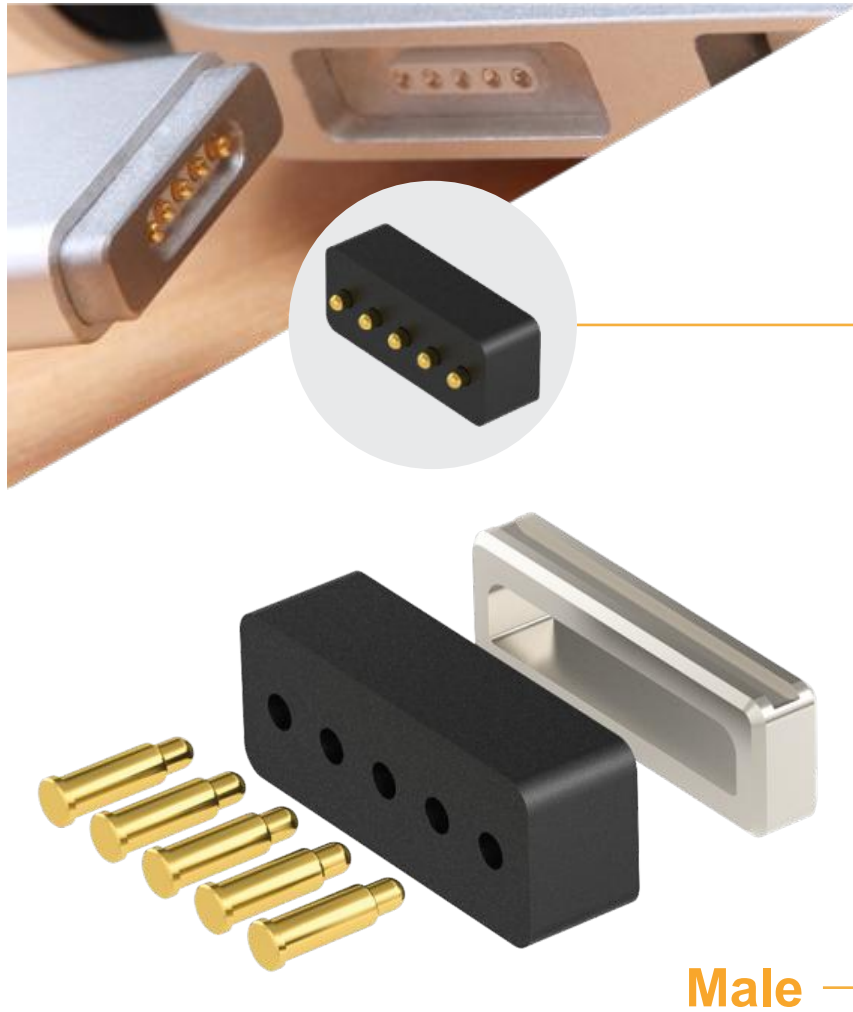

Magnet



Plastic Housing



Pogo Pin



Pogo Pin Connector - Magnetic Module Design

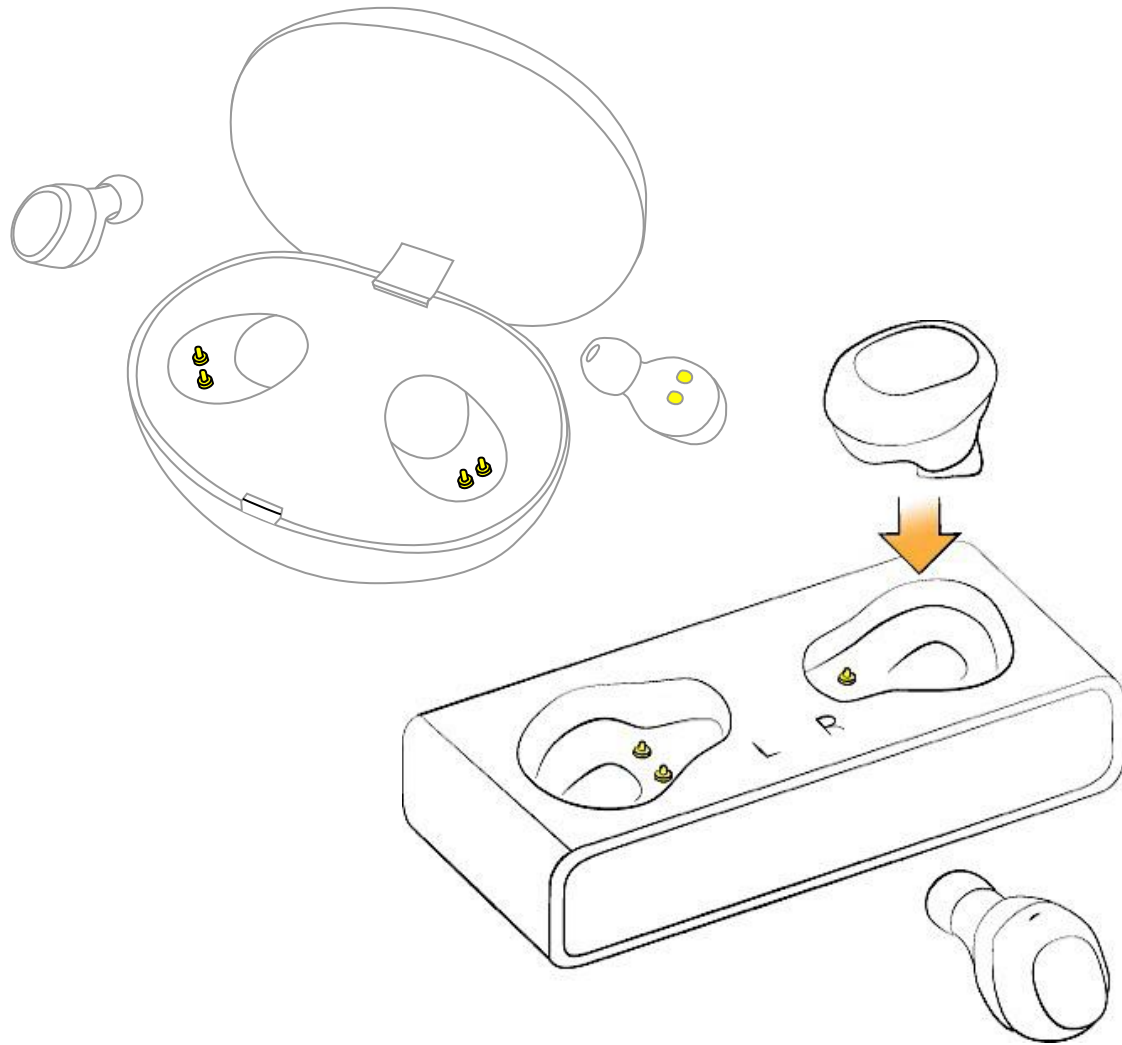



Pogo Pin Connector - Magnetic Module Design

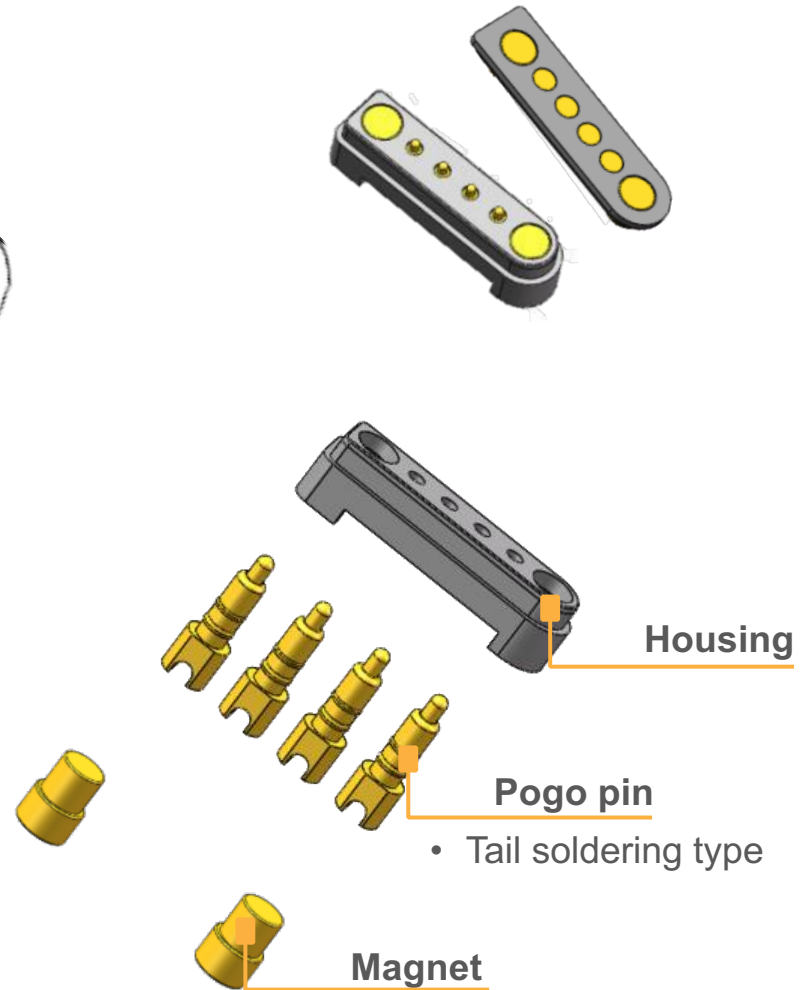
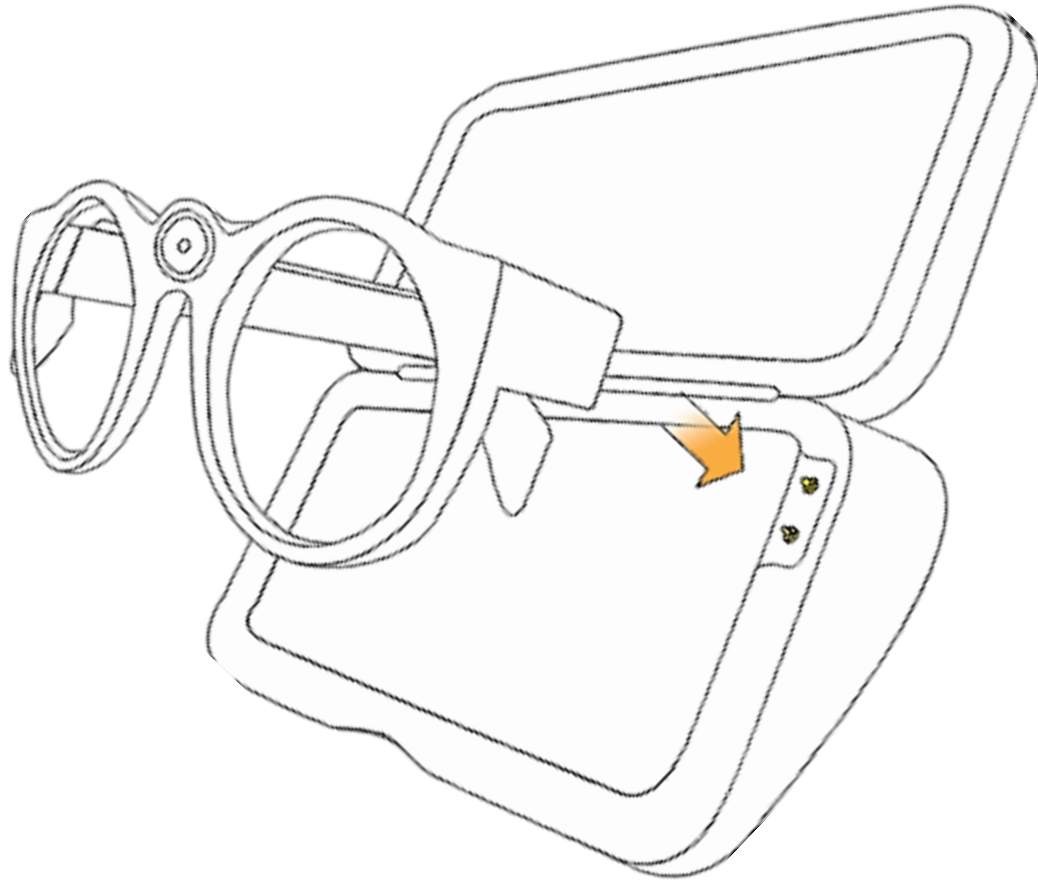

- Exposed magnet
- Pass salt spray/sweat test 48hrs
- Au plating



Pogo Pin Connector - High Current Pogo Pin

Thickened Structure



Cap Design

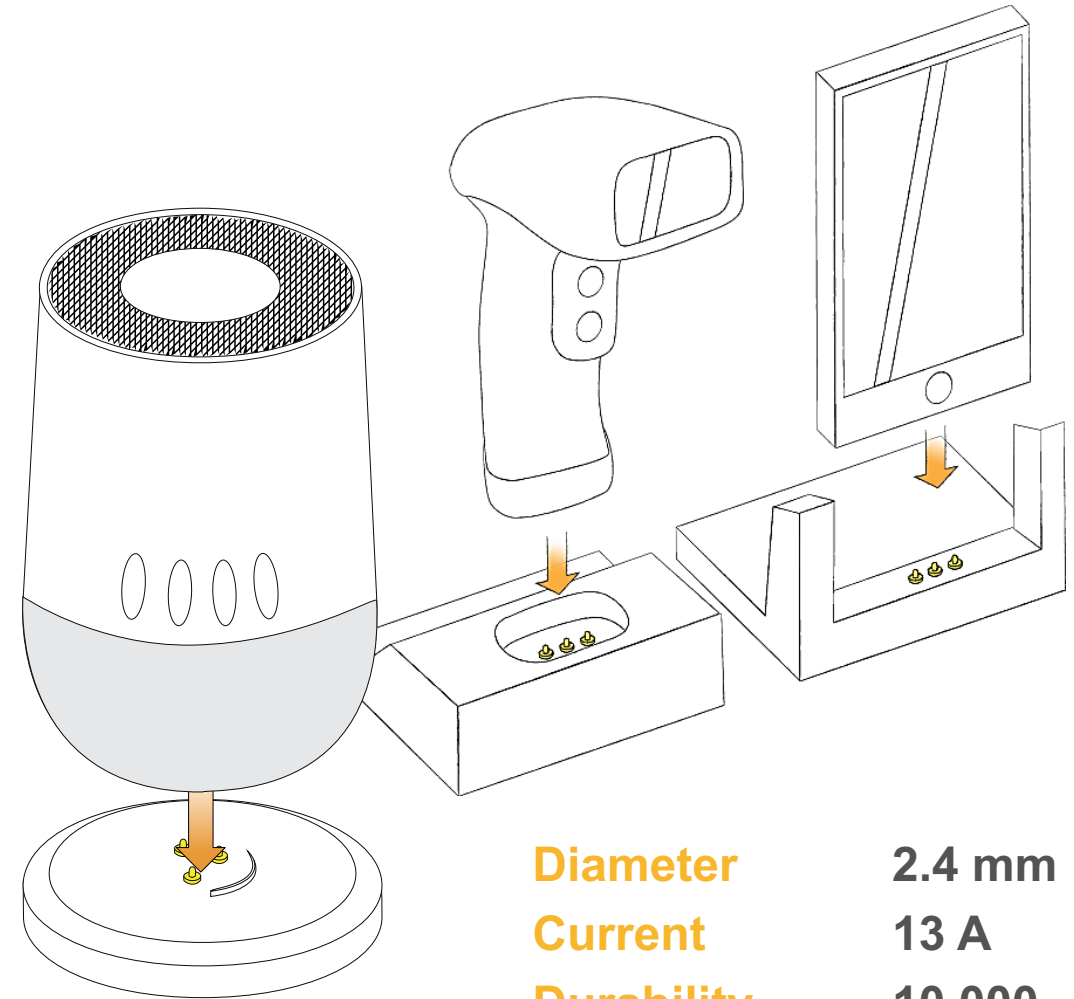

| | |
|---------------------|-------------------|
| Diameter | 2.4 mm |
| Current | 13 A |
| Durability | 10,000 |
| Spring Force | 120g ± 20g |
| Resistance | 30 mΩ |



Pogo Pin Connector - Docking Module Design

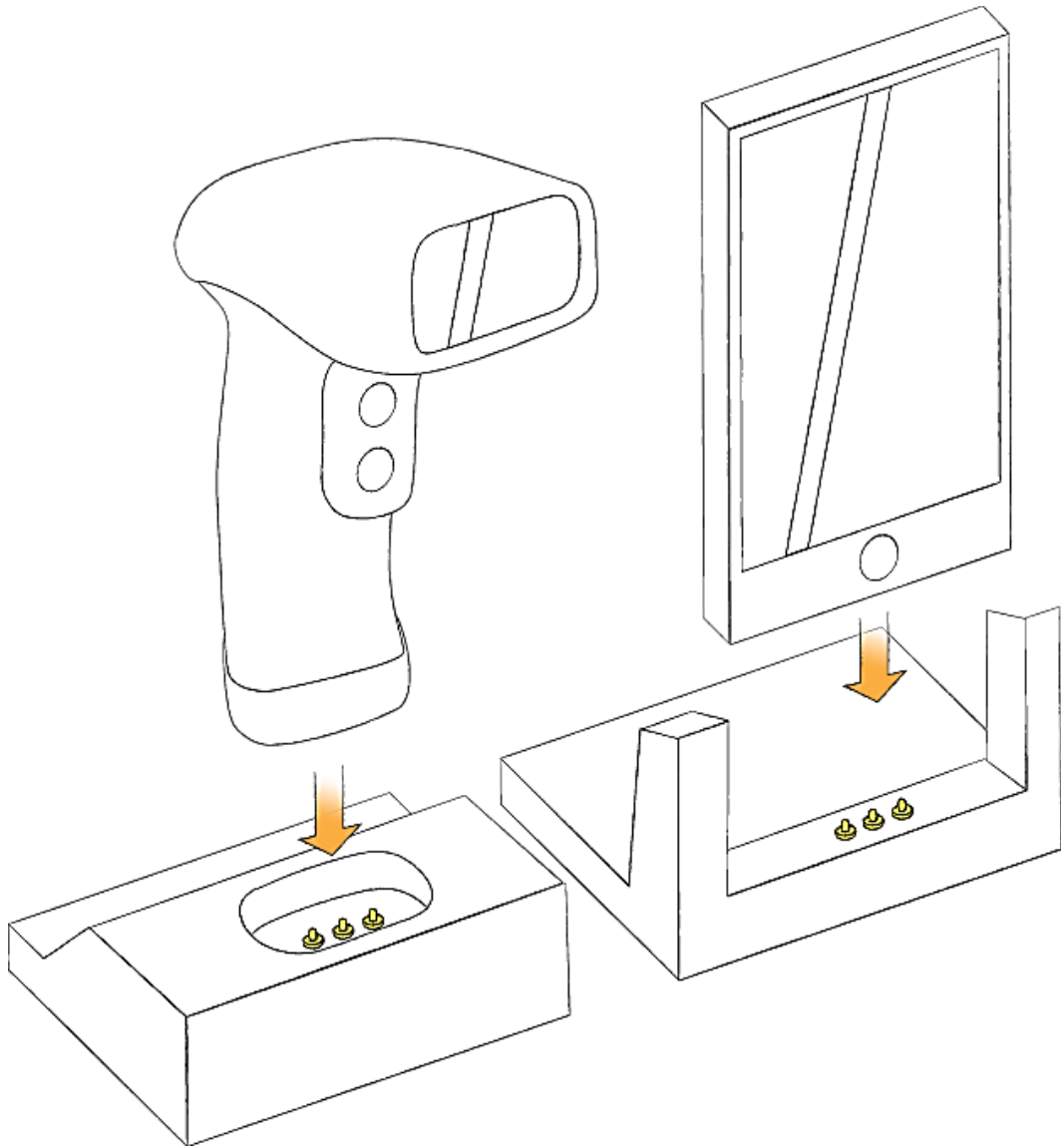

Application

Power Connection
Data Transmission

Advantage

Easy to Contact





Pogo Pin Connector - Ball Point Pogo Pin

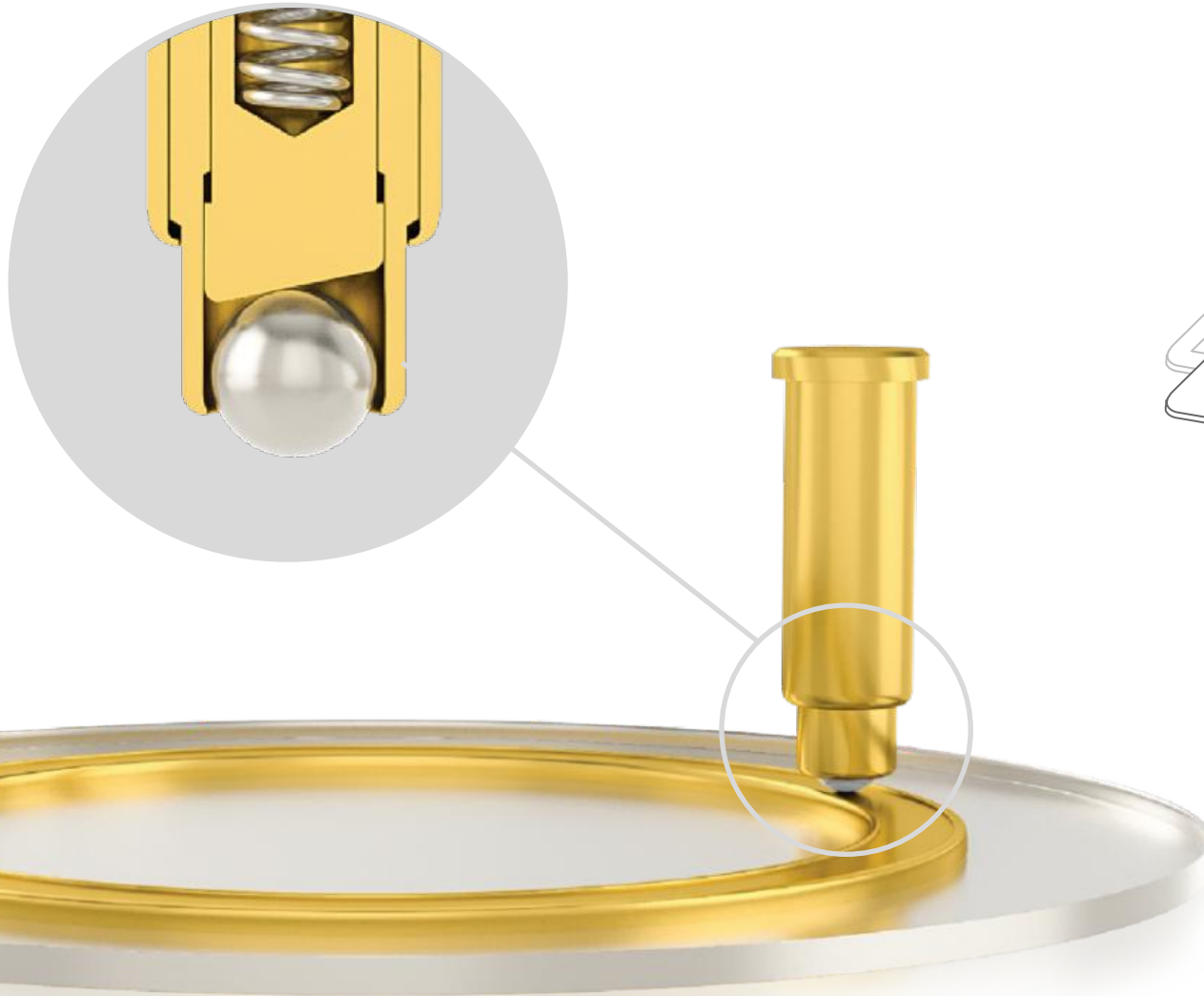

Product Display

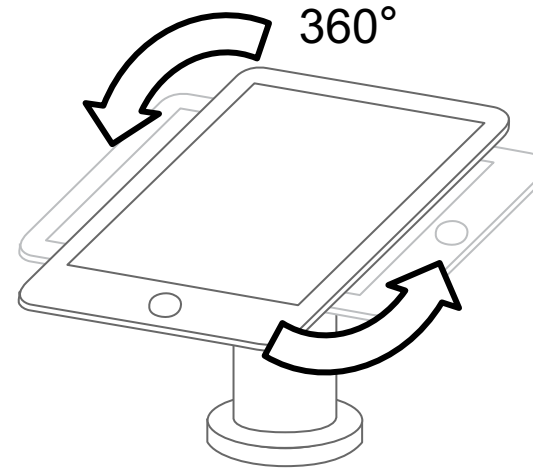

Camera

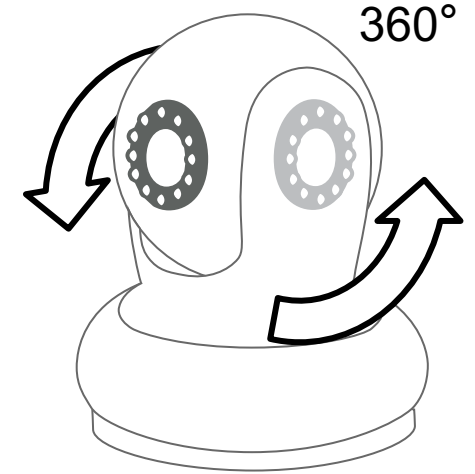

| | |
|-------------------------|---------------|
| Current | 1 ~ 5 A |
| Durability | 10,000 |
| Lateral Movement | 25,000,000 mm |
| Resistance | 100 mΩ |



Pogo Pin Connector - Rotation Docking Module

Application

Rotation Docking Connection
Hi-speed Data Transmission

Advantage

Customized Shape
Cosmetic Finish
Easy to Connect with Magnet

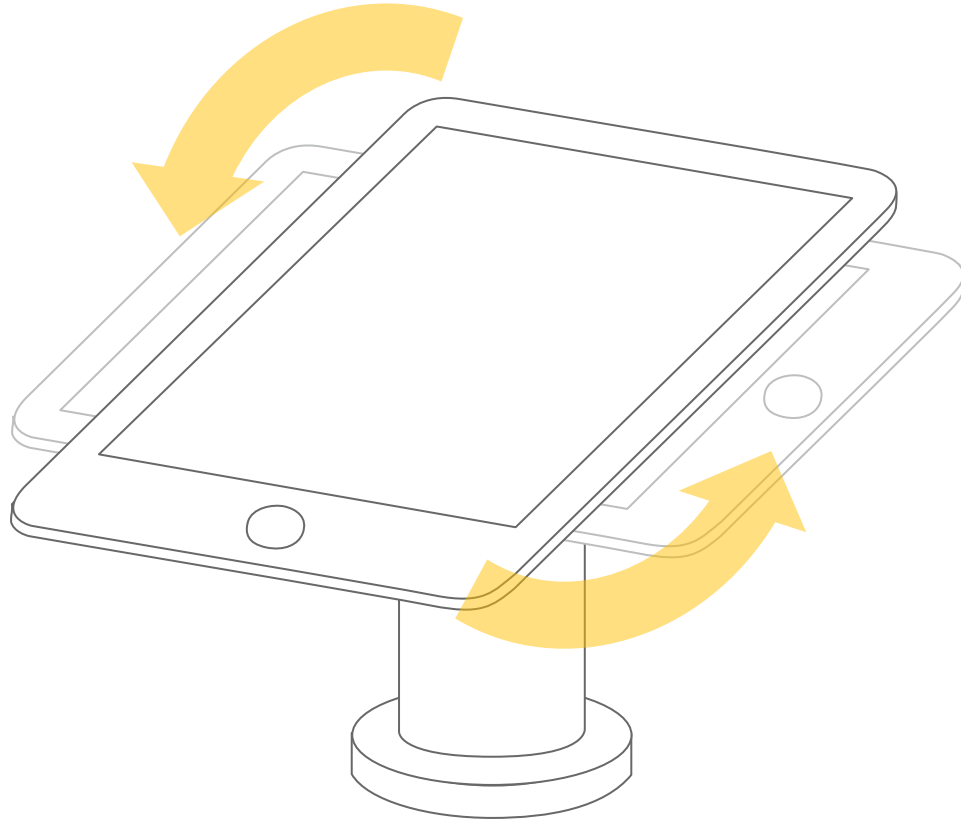



Pogo Pin Connector - High Frequency Connector

Metal Shell

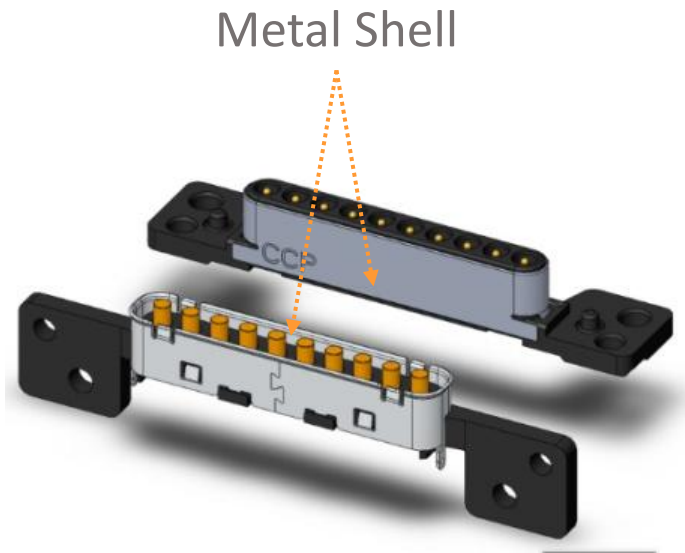

Coaxial

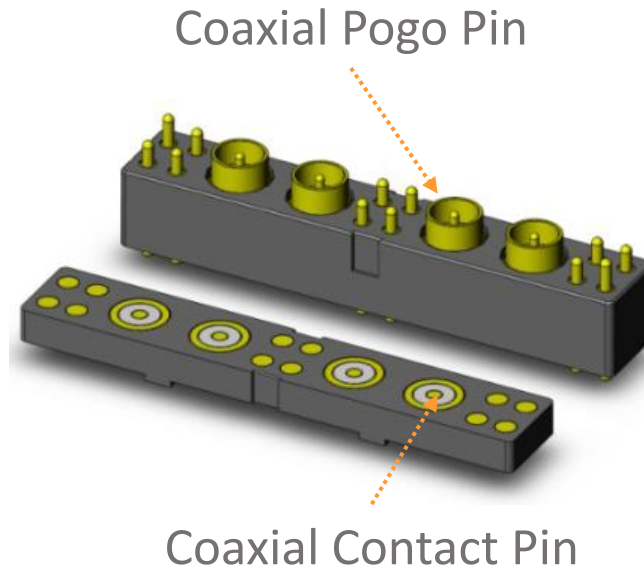

MIM Shell

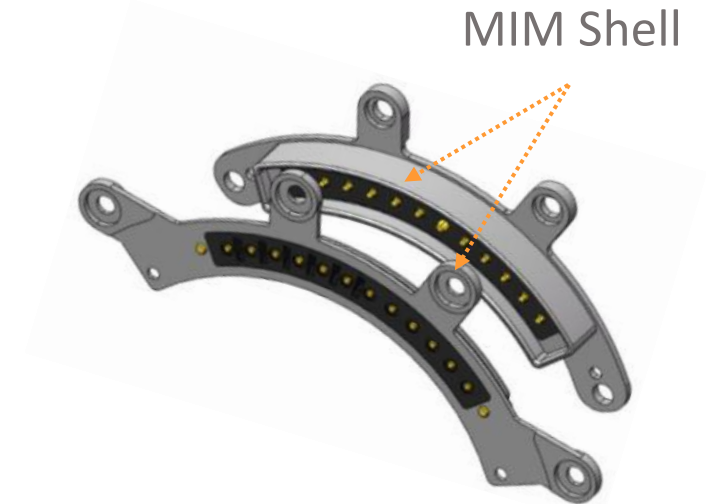



Pogo Pin Connector - High Frequency Application

High Frequency
Magnetic Matting
Desktop Docking

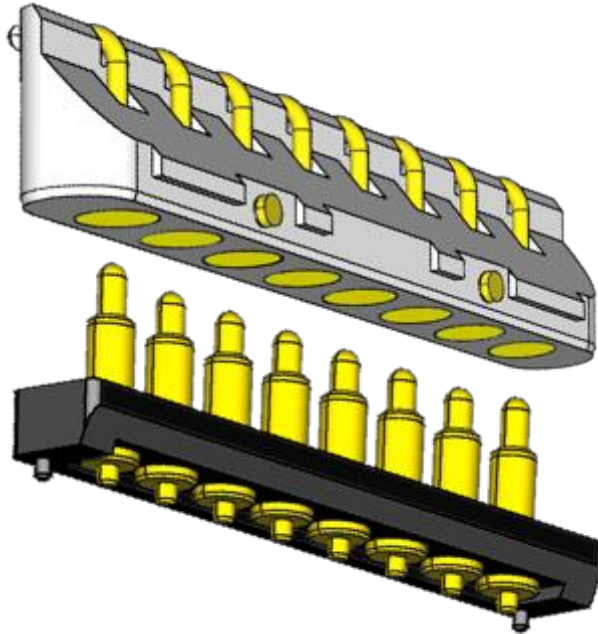

 Mating Area

 Tablet Side Female Connector

 Keyboard Side Male Connector



Pogo Pin Connector - Magnetic Modular Design



Satisfy USB 3.1 Data Transmission
Support Thunderbolt III Data Transmission
Fool-proof via Magnetic Pole
10,000 Life Cycles



Ultra Thin Pogo Pin
High-Speed pins Φ 0.35 mm
Ground Pin Φ 0.50 mm

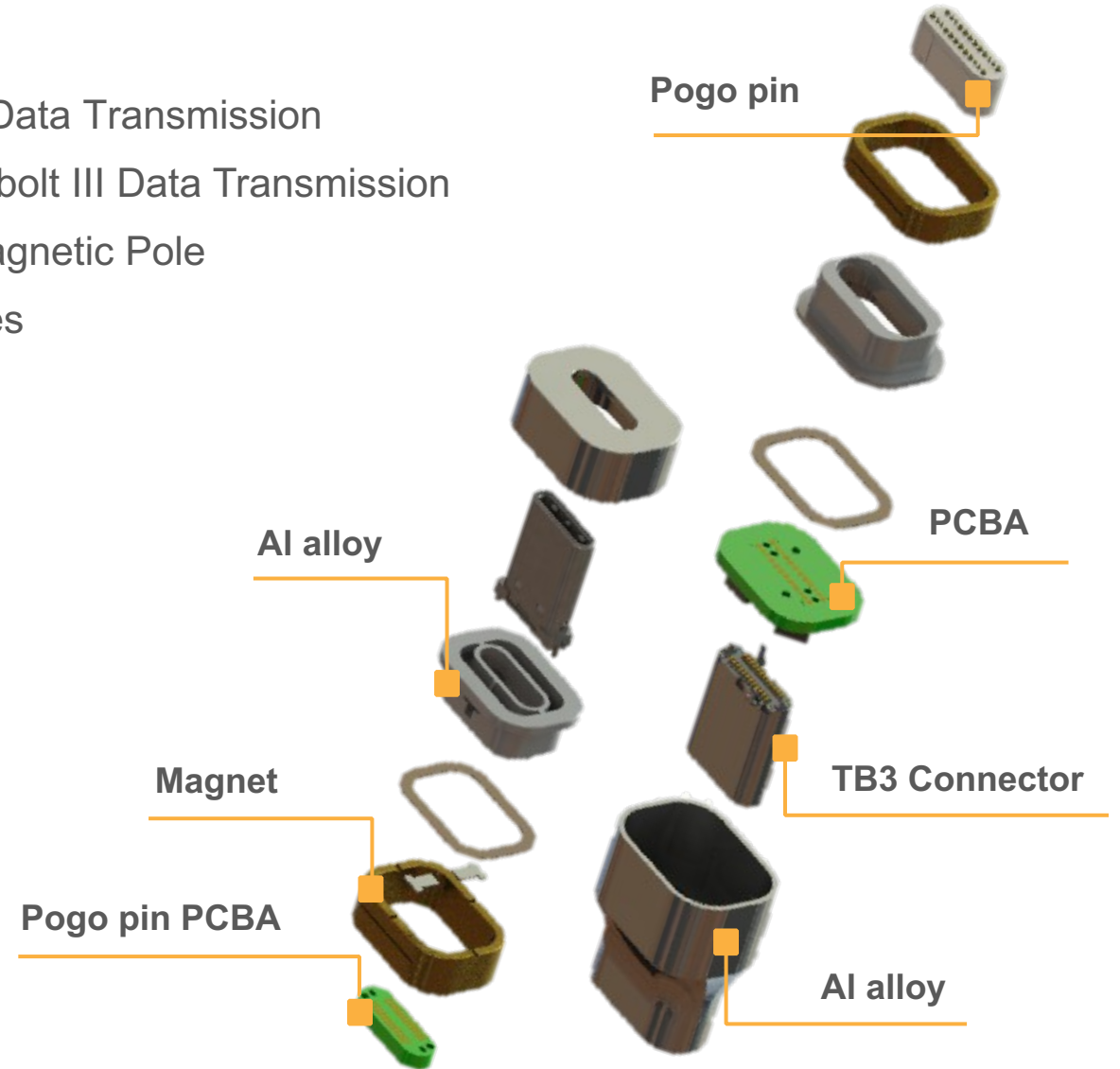



Pogo Pin Connector - Ultra Short Pogo Pin

Developed and designed to fit in compact devices
Feasible for mass production

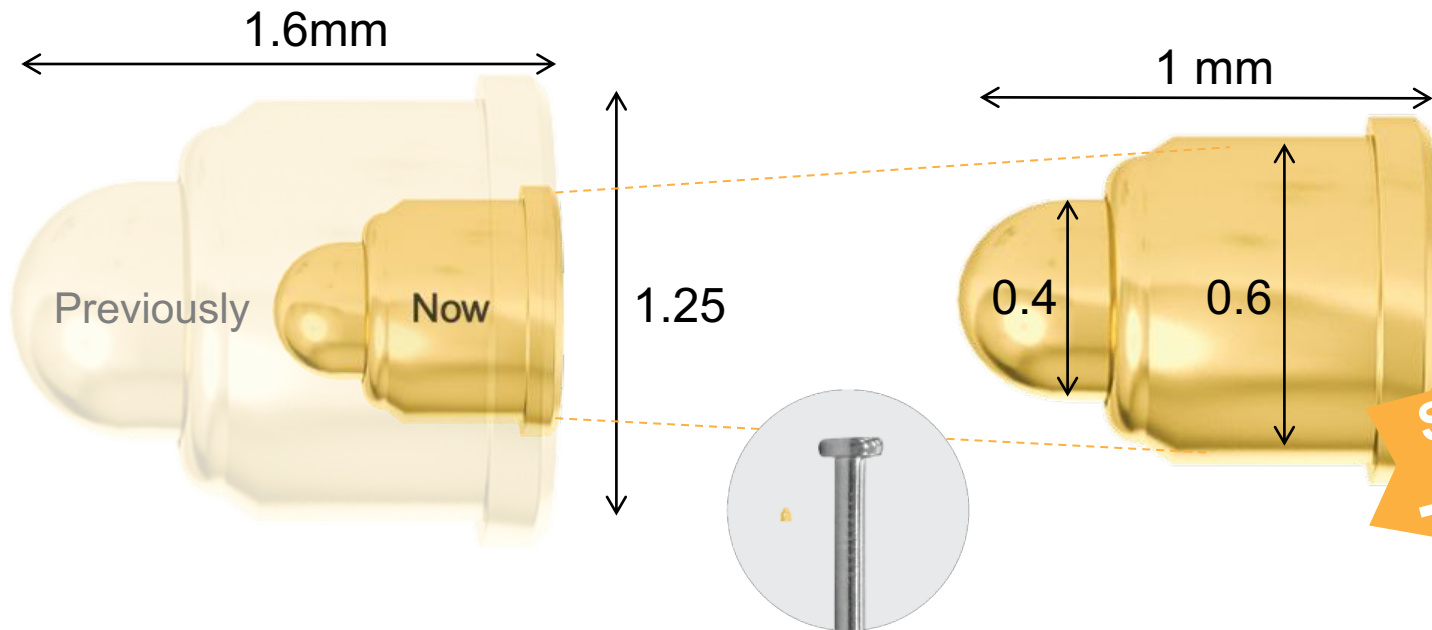
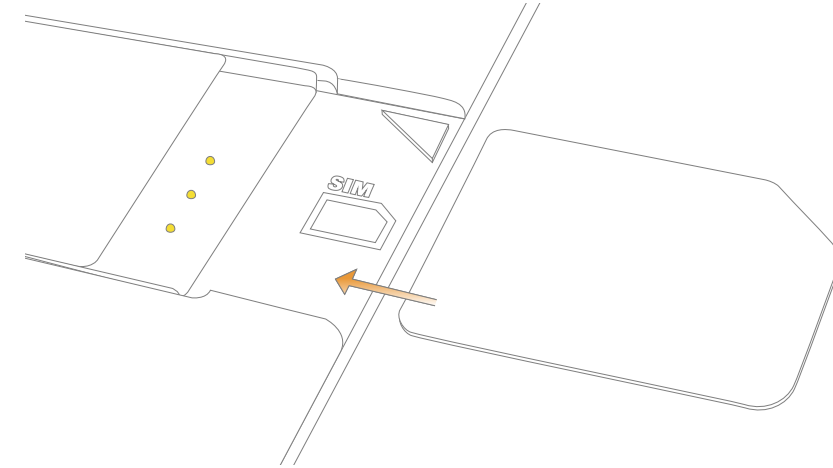

Size:
-60%

| | |
|---------------------|---------------|
| Diameter | 0.6 mm |
| Current | 1A |
| Durability | 3,000 |
| Spring Force | 25 g |
| Resistance | 170 mΩ |

Customized for grounding pin purpose



Pogo Pin Connector - Screw Pin

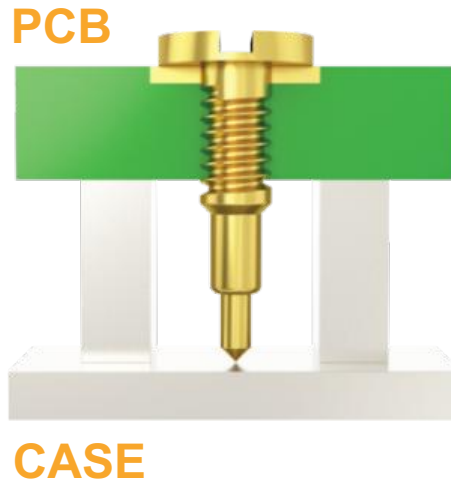
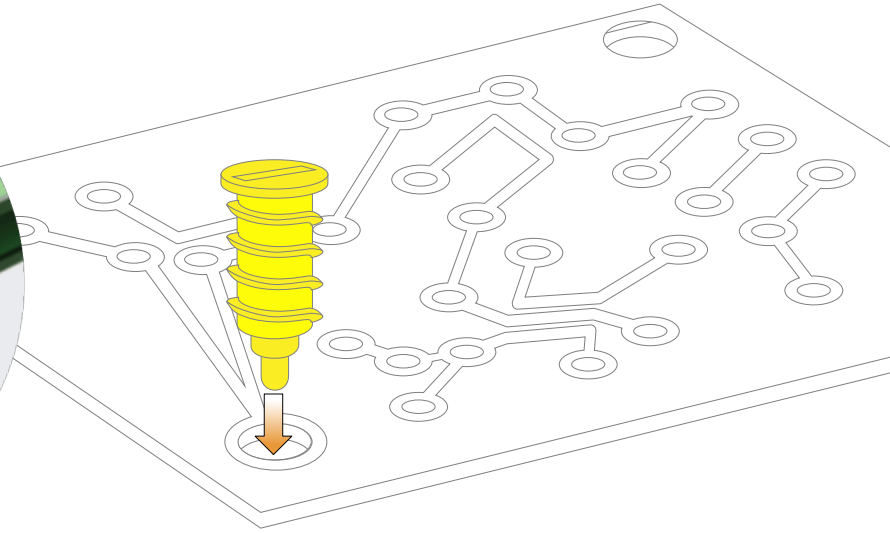
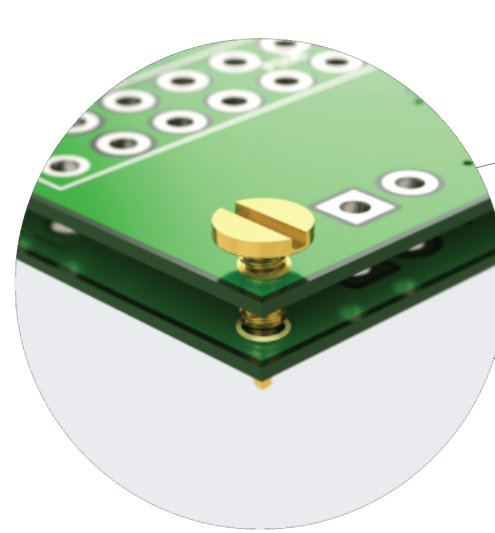
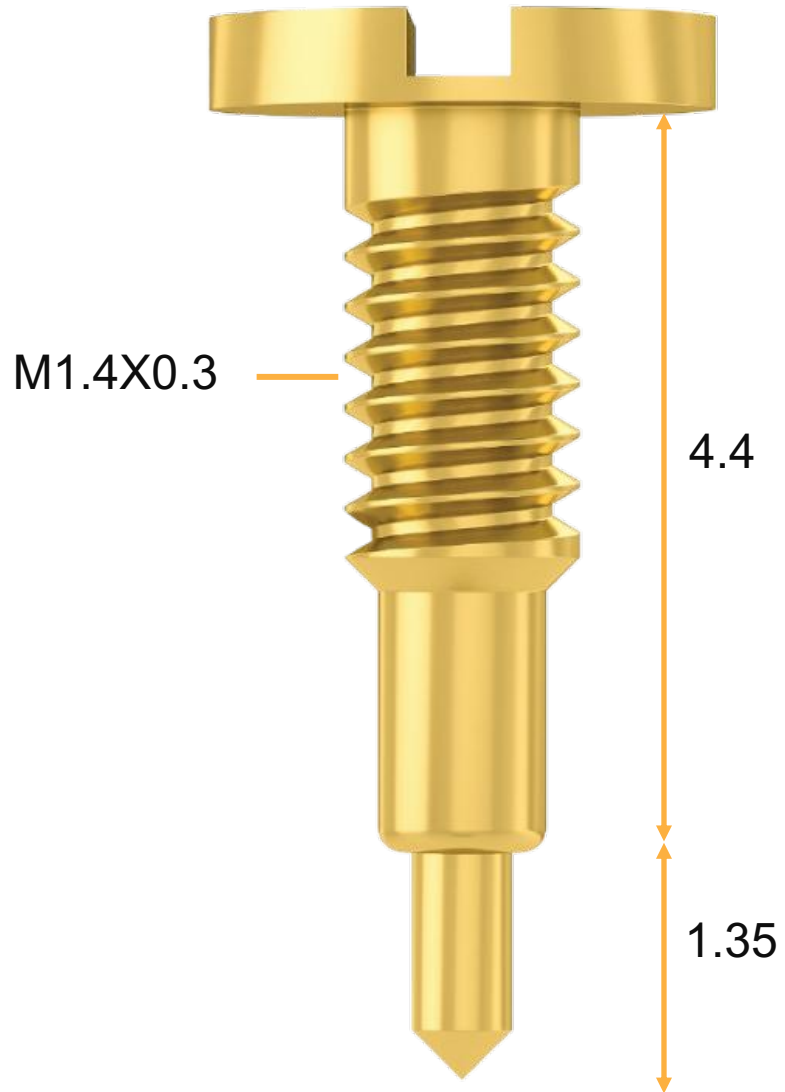

| | |
|---------------------|--------------------|
| Diameter | 3 mm |
| Current | 1 A |
| Durability | 10,000 |
| Spring Force | 120g ± 20g |
| Resistance | 200 mΩ |
| | Customer's Request |



Plating Technology - Anti-Electrolysis Plating



**CCP
Super AP**

0 Min



5 Min



10 Min



50 Min



Gold

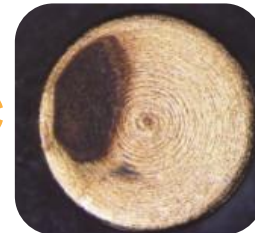
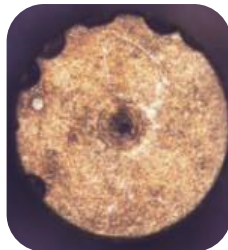
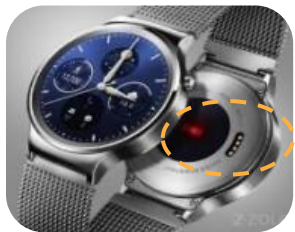



Plating Technology - Electroplating Capability



Plating Development
30 Years Experience
Automated Production Line
Online Plating Monitoring System
Capability: 3,000 Lot/Month

Automatic Degreasing



Function: Degreasing.
Max. Capability: 240 lot/day.
No damage to substrate & no wastewater.

Automatic Pretreatment



Function: Activation.
Max. Capability: 180 lot/day.
High efficiency.

Automatic Post-Treatment



Function: Protection & Cleaning production.
Max. Capability: 240 lot/day.
Consistent Quality

Fischer X-Ray



Function:
Measuring plating thickness.

PE AAS



Function:
Monitor ion concentration.



Plating Technology - Patent Plating Layer



| Plating | Testing Standard | Au(50u") Layer | AP Layer | APII Layer | Super AP Layer |
|----------------------------------|------------------------|---------------------------|---------------------|---------------------|---------------------|
| Color | / | Gold | Silver | Silver | Silver |
| Nickel Release | EN 12472:2005+A1:2009 | Nickel-containing process | Nickel-free process | Nickel-free process | Nickel-free process |
| Plating Thickness (micro inch) | XRF | 100~170 | 110-170 | 270~400 | 210~400 |
| Resistance (mΩ) | EIA-364-23 | < 50 | < 50 | < 50 | < 50 |
| Salt Spray Resistance (HR) | EIA-364-26 | 96 | 48 | 96 | 168 |
| Artificial Sweat Resistance (HR) | ISO-3160 | 96 | 48 | 96 | 168 |
| Surface Hardness (HV) | ISO 6507-1:2005 | 200 | 400 | 400 | 400 |
| Electrolysis Resistance Time | 1mA,5V,Pitch=0.60mm | <1min | 10min | 15min | 60min |
| Cost | Factor to Gold Plating | 1 | x0.9 | x2 | x3 |



Testing Solution - Integrated Manufacturing



Automatic CNC lath



CNC spring coiling machine



Surface treatment production line



Semi-automatic assembly machine



Automatic assembly machine



Automatic probe **full inspection**





Manufacturing Capability – Precision Machining



CAM Turret Machine: 105 Units
Capacity: 20KK
Precision: 0.005mm

CNC Turret Machine : 42 Units
Capacity: 2KK
Precision: 0.001mm

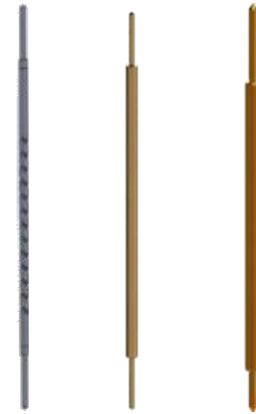

IC Test Probe



Pogo Pin



High Current
Pin & Socket



Customized



Testing Capability - Test Equipment

Electrical Performance



Network Analyzer



VNA (Vector Network Analyzer)



High Current Power Supply & Electronic Load



Contact Resistance Tester



RCA Tape Abrasion Tester

Mechanical Performance



Safety Comprehensive Analyzer



Mechanical Vibration/Shock

Environmental Testing



Oven



Waterproof test machine



Flush test chamber



Automatic Insertion Force Tester



Durability Cycling Machine



Thermal shock test machine



Salt spray test machine



Temperature & humidity test machine

Other



Hot-Air Reflow machine



3D laser scanning microscope



X-ray



Electrochemical workstation



Terminal cross section analyzer



Quality System

ISO 9001:2015

Quality Management Systems

IATF 16949:2016

Automotive Quality Management System

ISO 14001 : 2015

Environment Management Systems

QC 080000

Hazardous Substance Process Management

ISO 13485:2016

Medical Devices Quality Management Systems



Quality Assurance

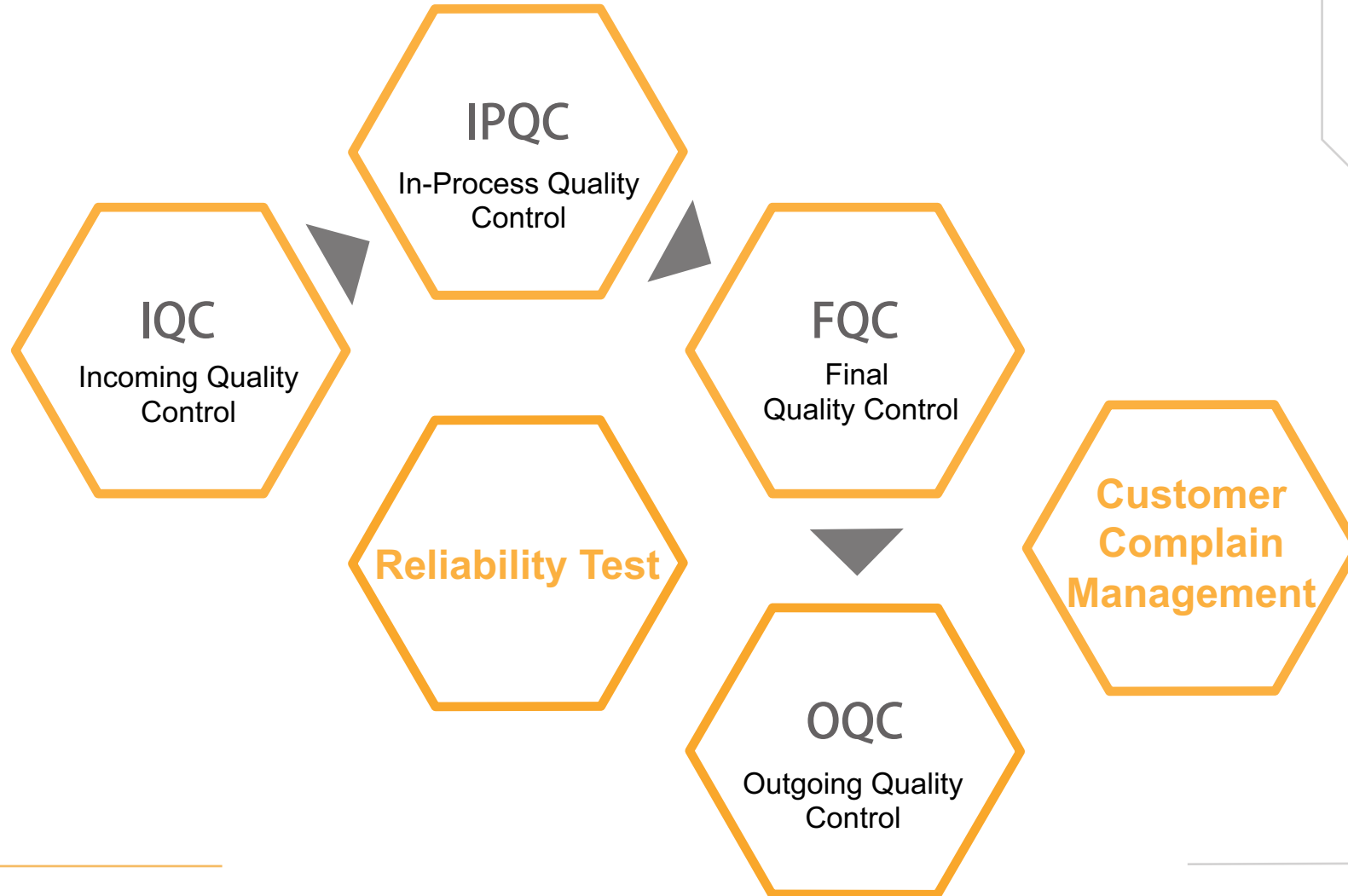



Verification Ability

Testing Items

Environmental

Waterproof

Humidity Test

Salt Spray

Thermal Impact

Resist. to Solder Heat

Vibration

Electrical

Contact Resistance

Insulation

HIPOT

Rated Current

Mechanical

Retention Force

Life Cycle

Vibration

Mechanical Shock

Other

Drop

Soldering Side Force

Solderability



Testing Equipment

Rated Current

Max Rating : 1000Amp



Waterproof

Test Level : IPX7 Up

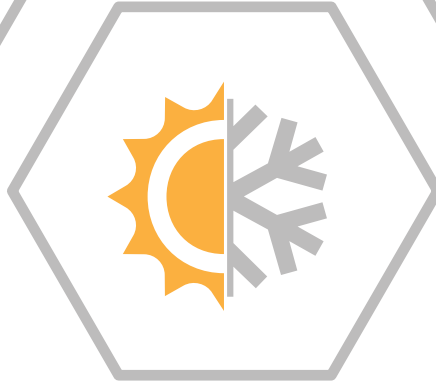

Thermal Impact

Range : -60~120°C

Resolution : 0.01°C



Vibration

Frequency : 3500Hz Max.

Acceleration : 50G Max.



Certificate



- ISO 9001
- ISO 13485
- ISO 14001
- ISO 14064
- IATF 16949
- IECQ QC080000





Social Responsibility

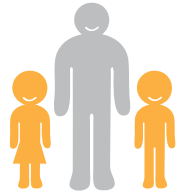

Summer camp for employees' children



Home visit to employees around the world



CCP offers tuition scholarship for employees' children

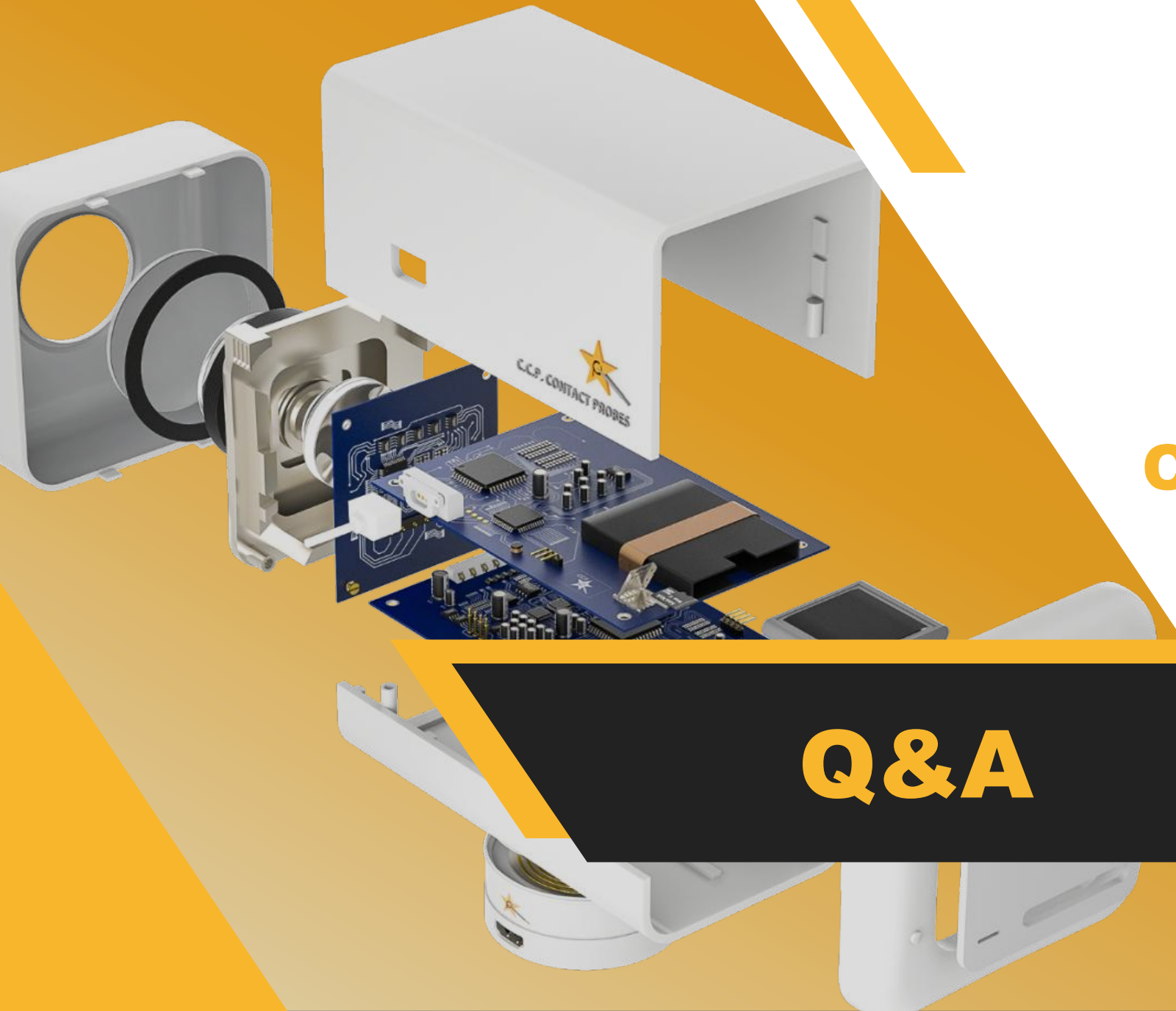

CCP Contact Probes

Q&A

info@pccp.com.tw
www.ccpccontactprobes.com

