

CCP Contact Probes

Company Introduction



CCP Contact Probes – Product Applications



Wearable Devices

TWS / Smart Watch /
VR/AR Headset

Pogo Pin Connector
Charging Cable
Charging Case
Housing



Charging Stations

Smart Home / Tablet /
POS System

Pogo Pin Connector
Charging Dock
Charging Cable



Healthcare Devices

Brain Wave Headset /
Hearing Aids

Pogo Pin Connector
Charging Case
Charging Cable
Waterproof USB Type-C



Electric Vehicle

EV Charging Station / Battery
System / E-Bike Connector

Crown Spring Terminal
Charging Gun
Battery Connector
E-Bike Connector



CCP Contact Probes - Growth



Collaborate with Top 10 the World's Most Valuable Brands
Over 1000% Growth in the Past 15 Years

Semiconductor and New energy sectors report stable growth

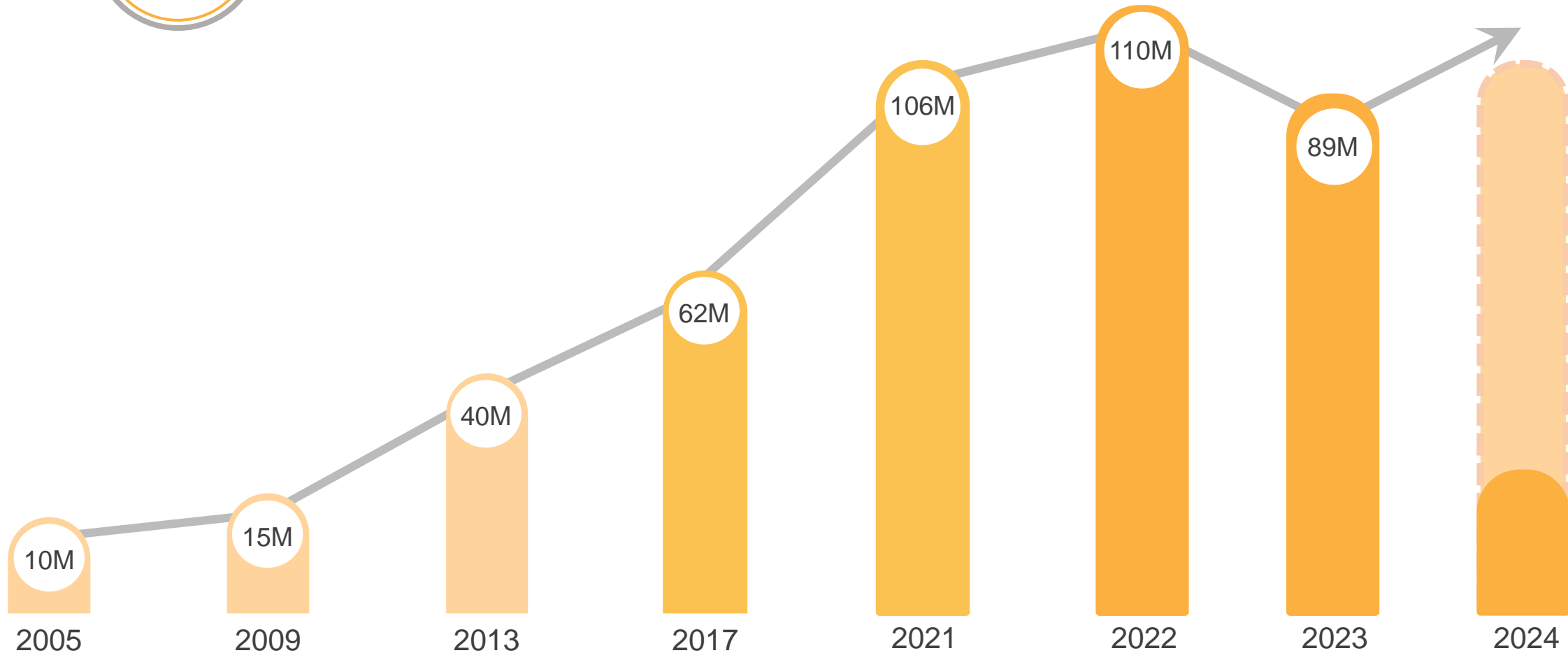



CCP Contact Probes – 2023 Revenue

2023 Financial Overview (By Region):

Total: **\$89.5M**

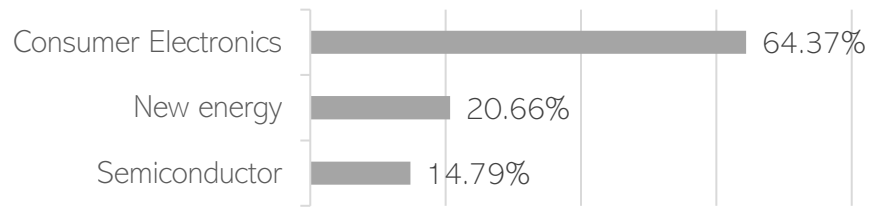

- China: \$54.2M (60.5%)
- Taiwan: \$35.5M (39.5%)

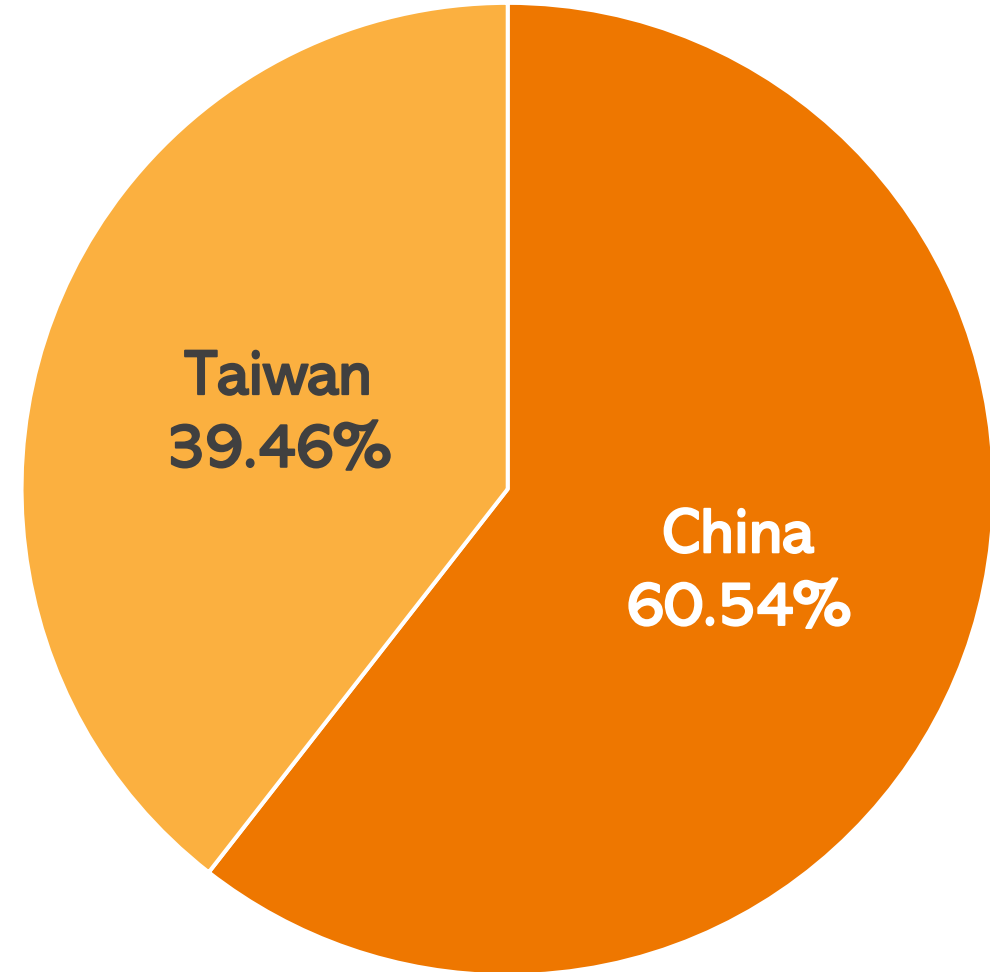

■ China ■ Taiwan



CCP Contact Probes - Worldwide

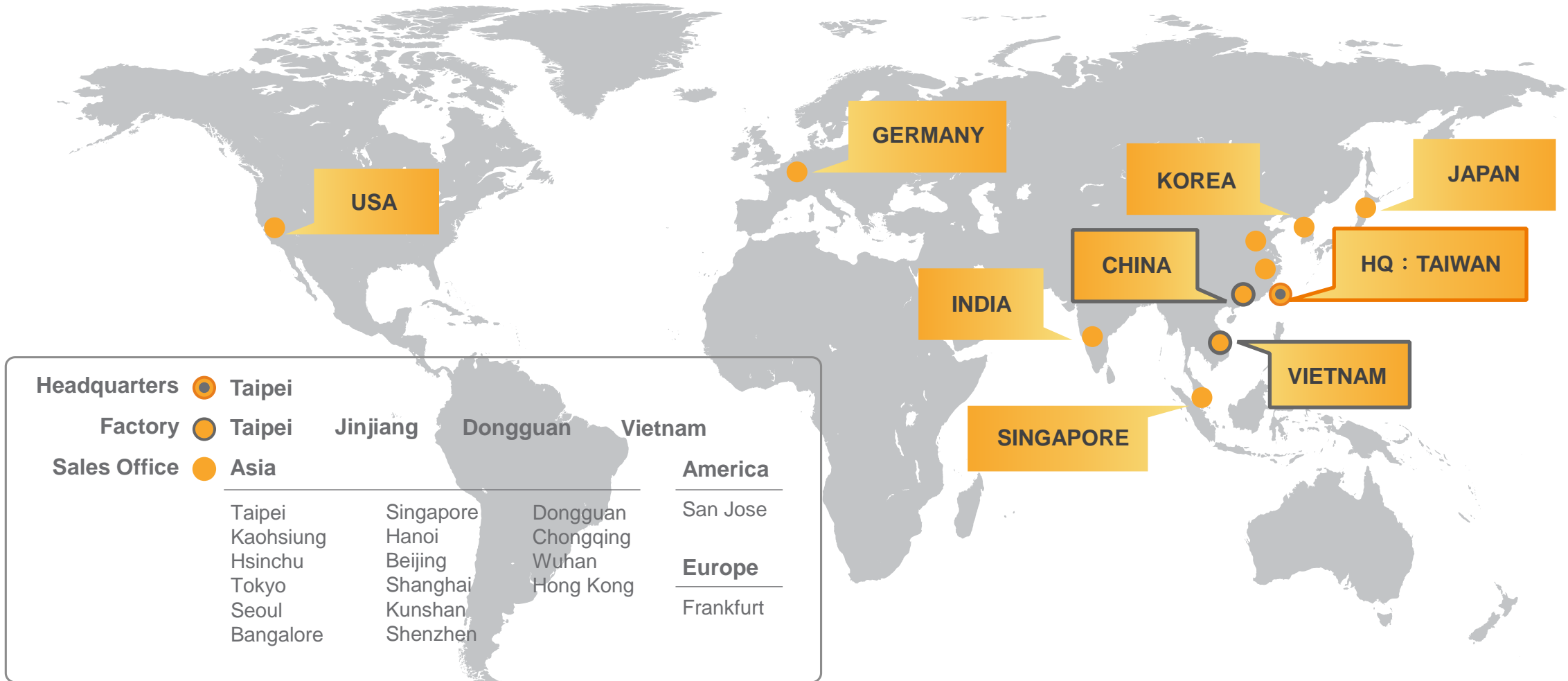



CCP Contact Probes - Product Portfolio

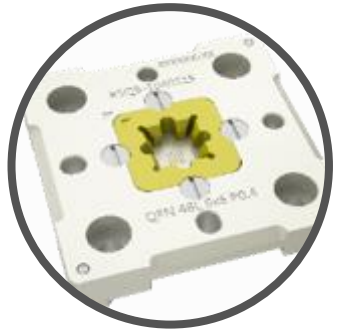

Testing Solution

Fine Pitch

IC Testing Probe
PCB Testing Probe
Testing Socket



Pogo Pin Connector

1A~13A

Pogo Pin Conn.
Waterproof Conn.
Magnetic Conn.



High Current Connector

13A~250A

Electronic Vehicle
High Current Conn.



Medical Connector

Environmental Sensitivity

Circular Conn.
Endoscope Conn.

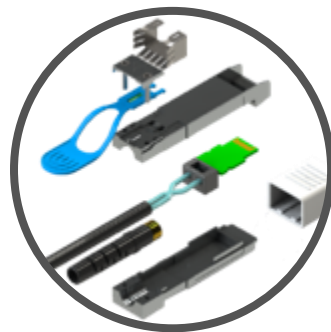

High Speed Cable

25Gbps~100Gbps

Server
Switch
Telecom



Industrial Solution

Extreme Environment

Aerospace
Military
Transportation



Pogo Pin Connector Product Line



TWS Earbuds



AR/VR Headset



Smart Doorbell



Smart Watch



2 in 1 Tablet & Stylus



E-Cigarette





Pogo Pin Connector Product Line

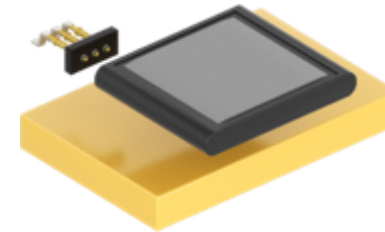
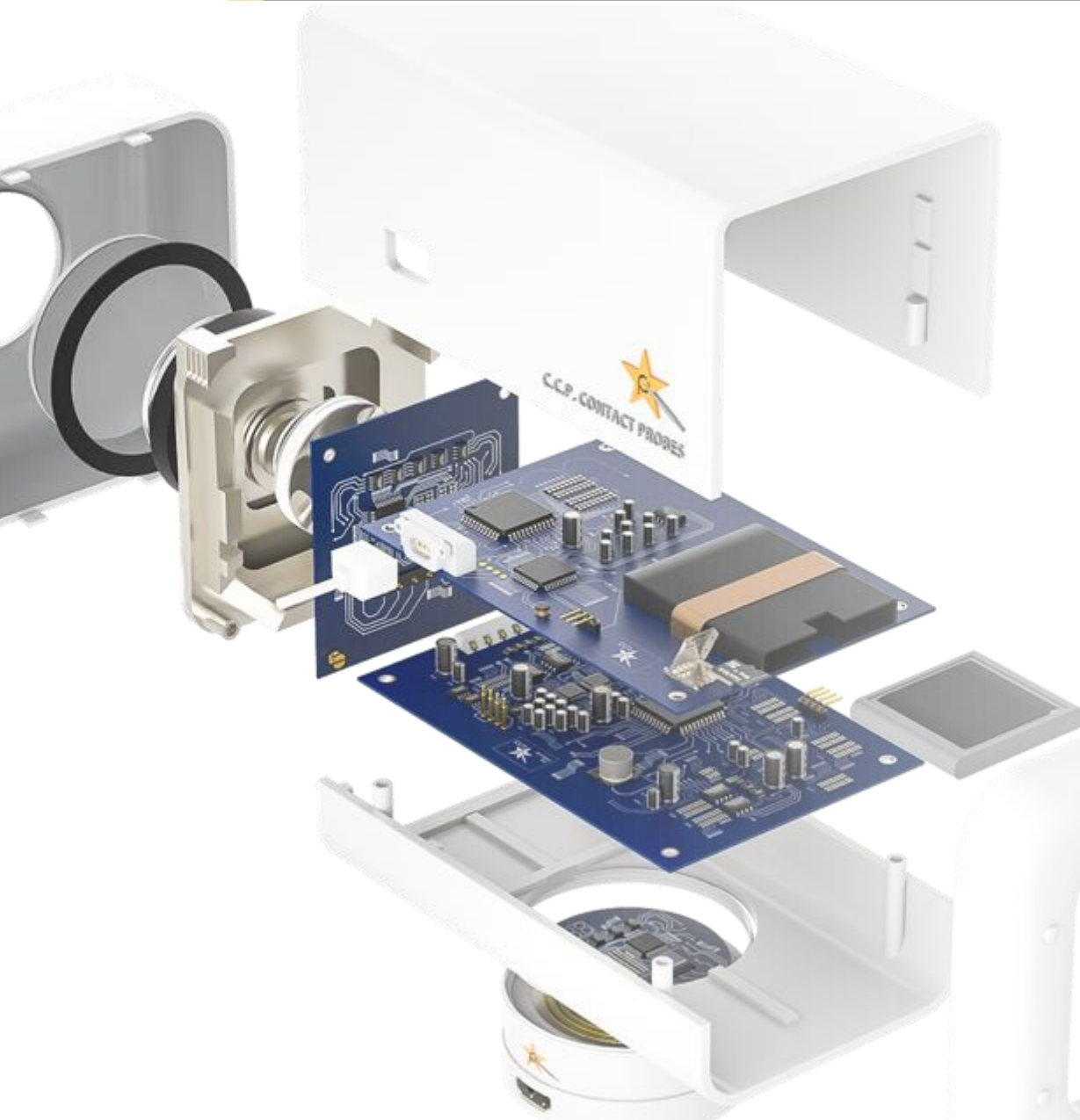

Battery Connector



Waterproof / Magnetic Charging Module

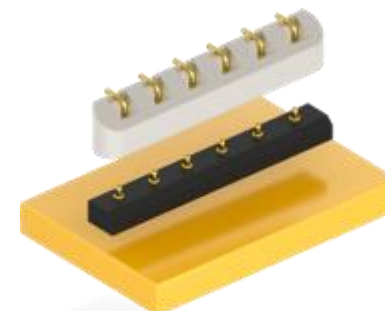

High Frequency Connector

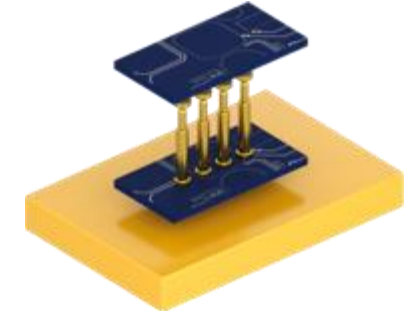

Board to Board Connector

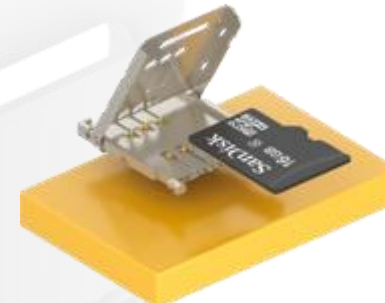

Ultra Small Pogo Pin



Sliding Connector



Pogo Pin Connector – Basic Structure

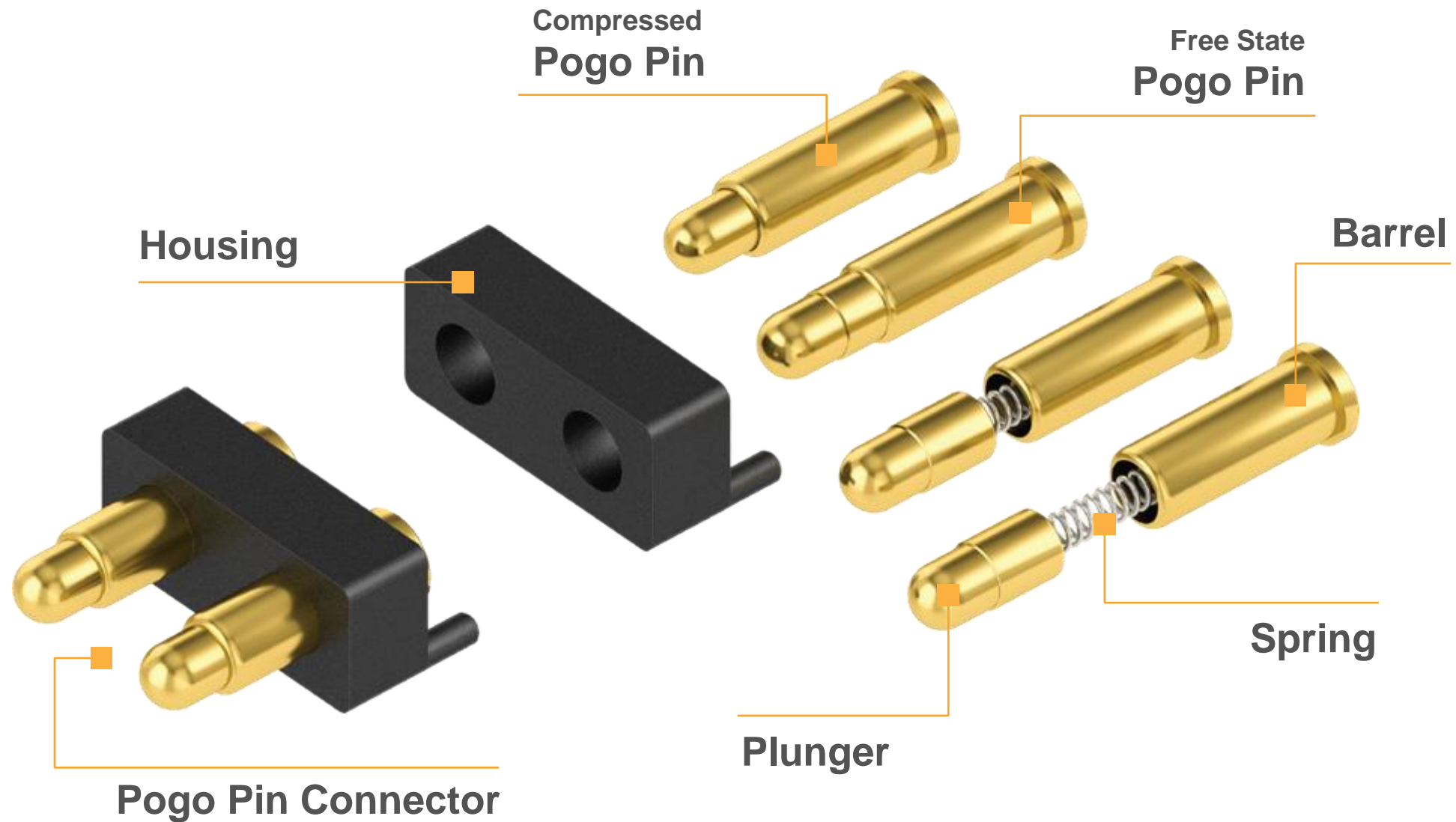



Pogo Pin Connector – Material & Plating Options

Ball

Stainless Steel

Plunger

Brass (Standard)

Beryllium Copper
Phosphor Bronze
SK4

Surface Plating
Base Plating
Base

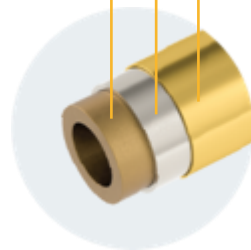

Color Options

PdNi 10u" over Ni 100u" (Silver)
Ru 10u" over Ni 100u" (Black)

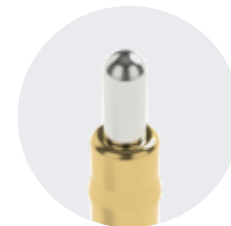

Housing

Polyoxyethylen (Standard)
PBT Polybutylene Terephthalate
LCP Liquid-Crystal Polymers
HTN Polyphthalamide
PA10T

Barrel

Brass (Standard)
Beryllium Copper
Phosphor Bronze

Spring

Stainless Steel

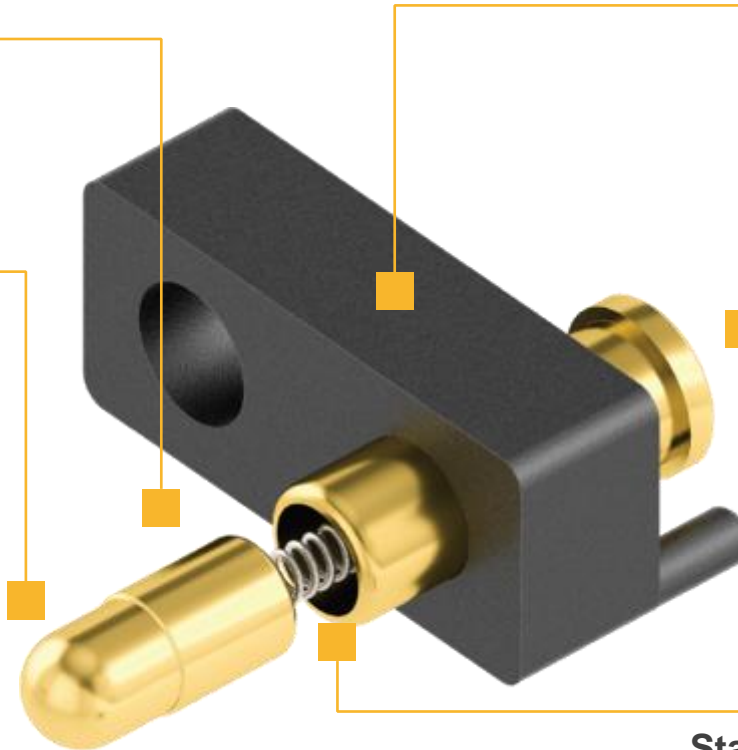



Pogo Pin Connector – Basic Inner Structures

Back Drill

The drilled tail makes extra space for spring and creates a shorter pogo pin.

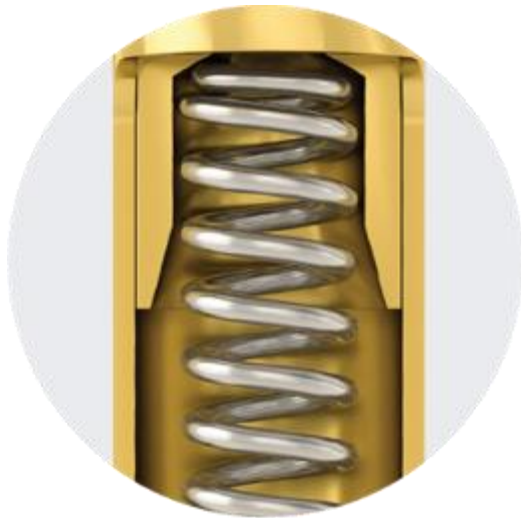

Pin Length: ≈ 2.5 mm
Current: **1 A**

Bias Tail

The bias tail of plunger creates lateral force and better contact.

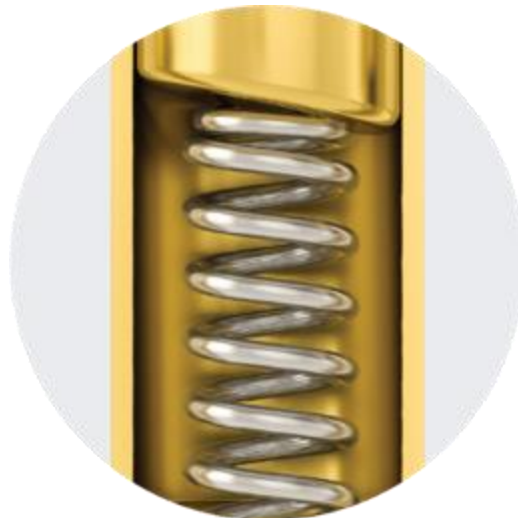

Pin Length: ≈ 3.5 mm
Current: **2 A**

Ball

The ball inside stabilizes the contacting areas for a better performance.



Pin Length: ≈ 4.5 mm
Current: **3~5 A**



Pogo Pin Connector – Waterproof Pogo Pin Connector

Sealing



Pitch: **Small**
Waterproof: **IPx7 at best**
Production Complexity: **Low**

Insert-Molding



Pitch: **Small**
Waterproof: **IPx7 at best**
Production Complexity: **Low**

O-Ring



Pitch: **Large**
Waterproof: **IPx8 at best**
Production Complexity: **High**



Pogo Pin Connector – Waterproof Application



Assembly & glue module

- IPX7
- Electrolytic resistant design

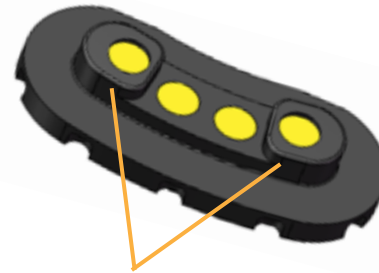

Electrolytic resistant design

- Steps feature on housing

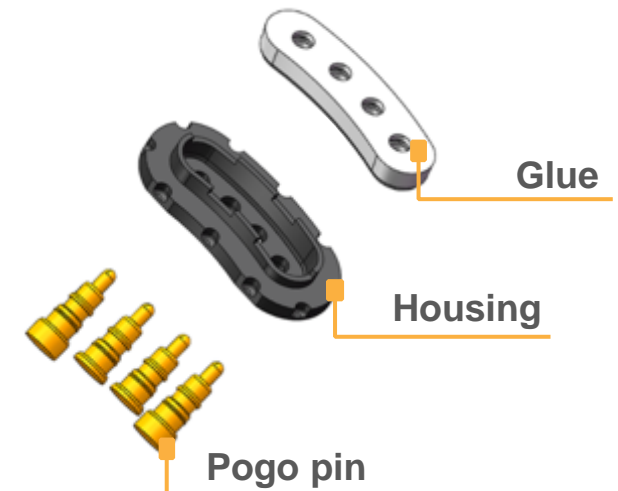



Pogo Pin Connector – Magnetic Connector

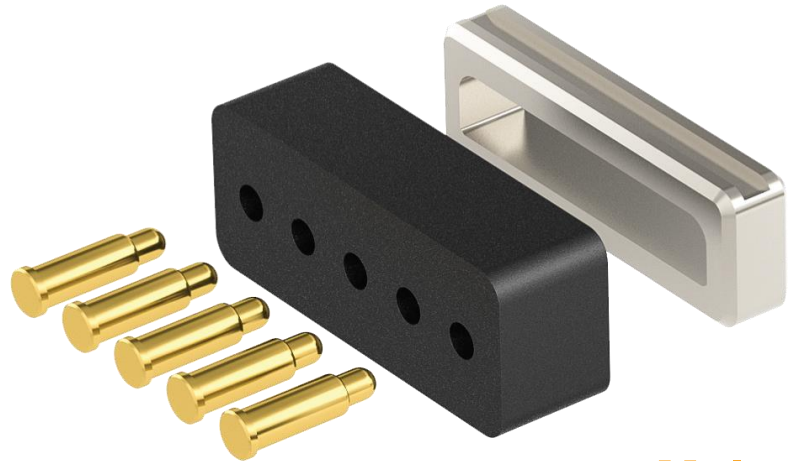
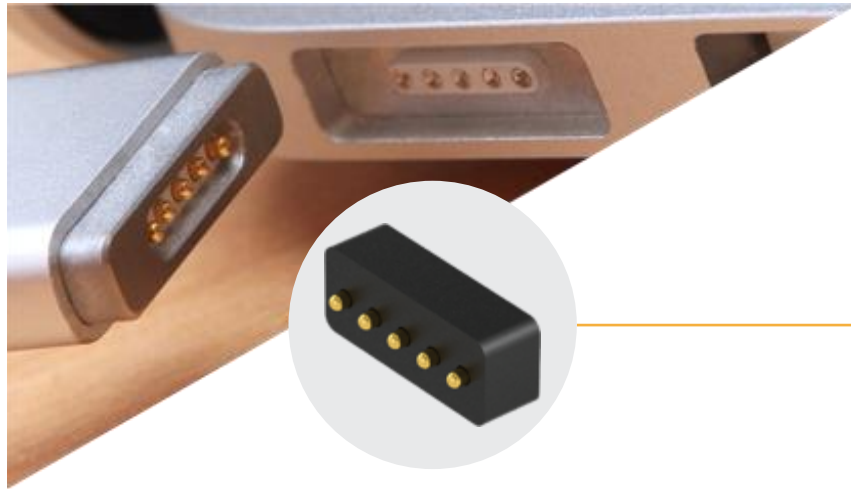

Male

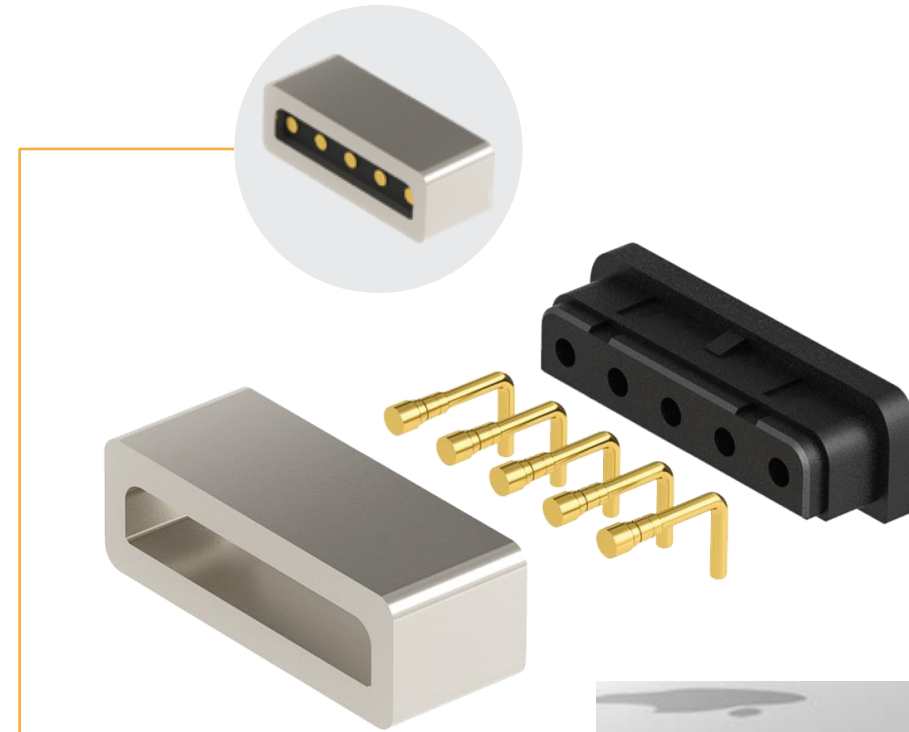

Female



Magnet



Plastic Housing



Pogo Pin



Pogo Pin Connector – Magnetic Module Design

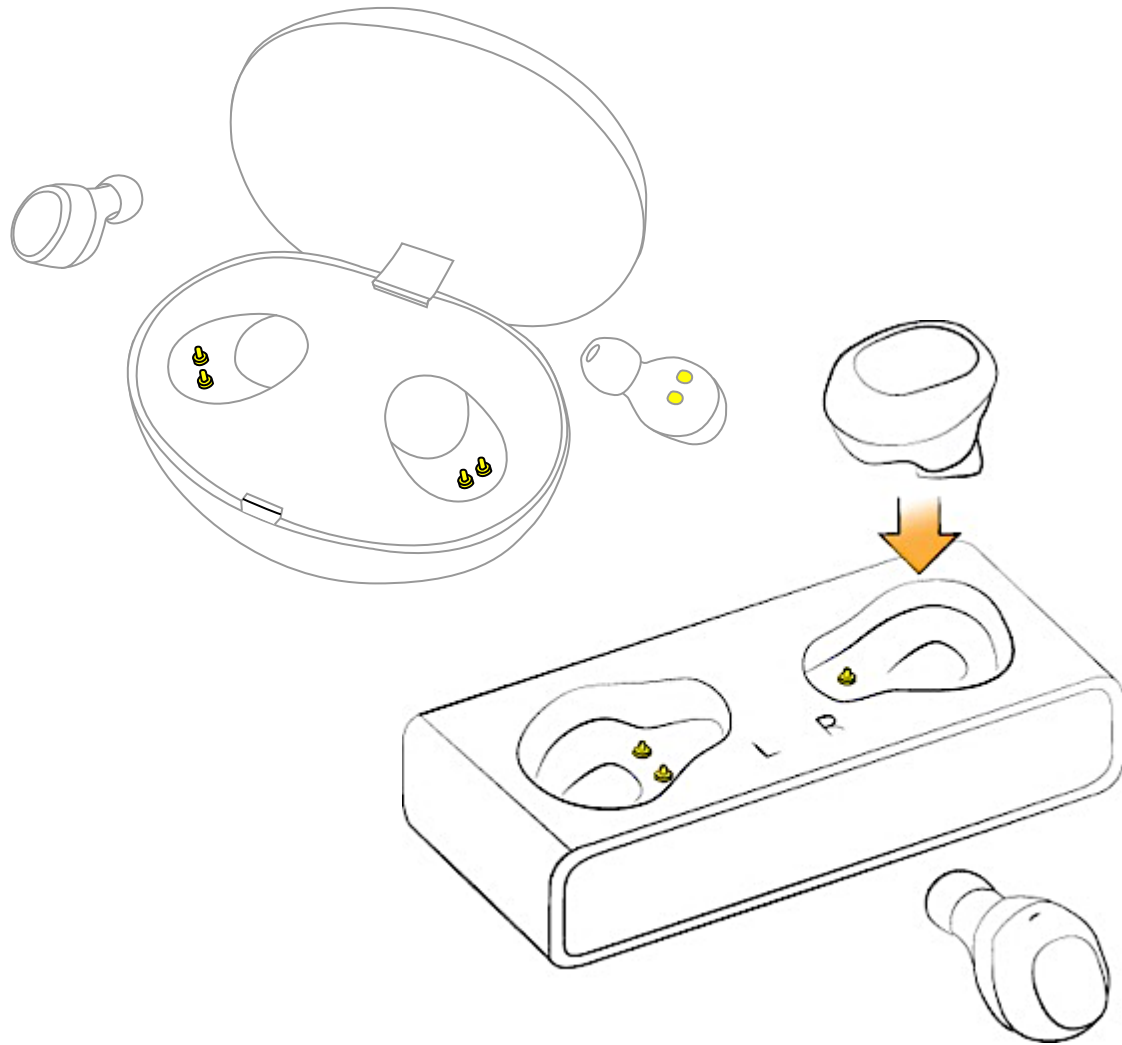



Pogo Pin Connector – Magnetic Module Design

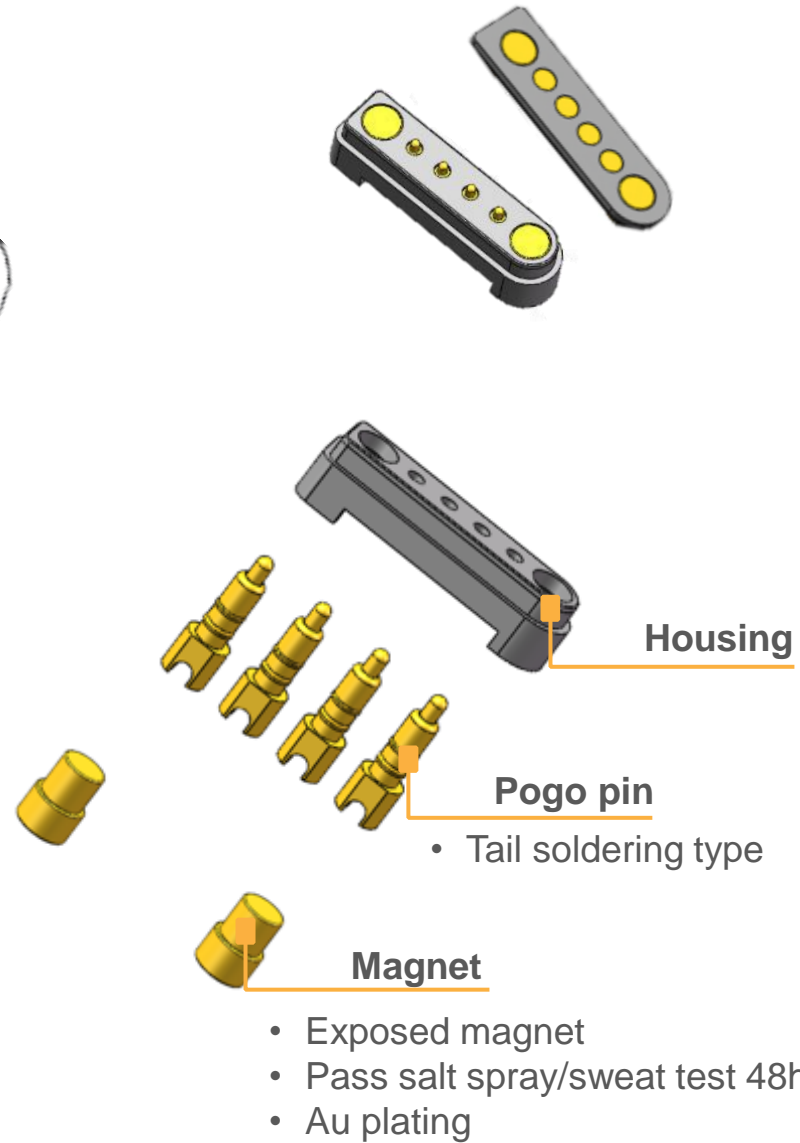
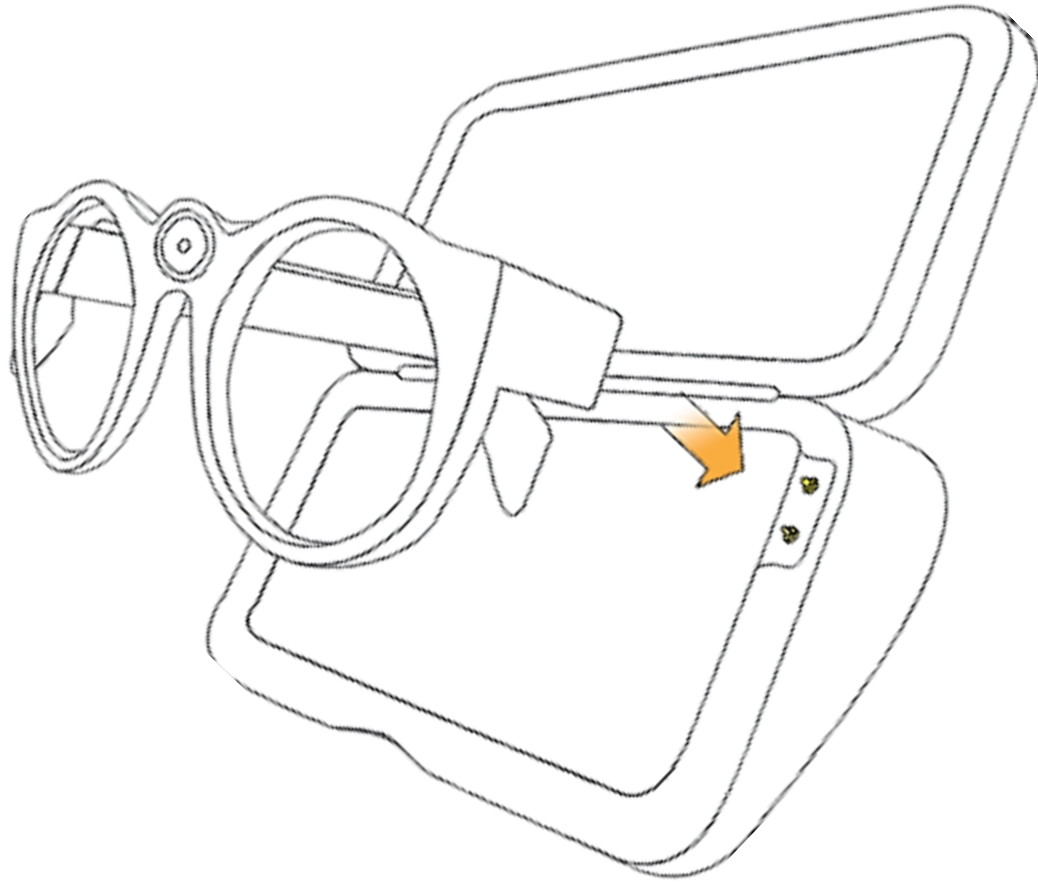



Pogo Pin Connector – High Current Pogo Pin

Thickened Structure



Cap Design

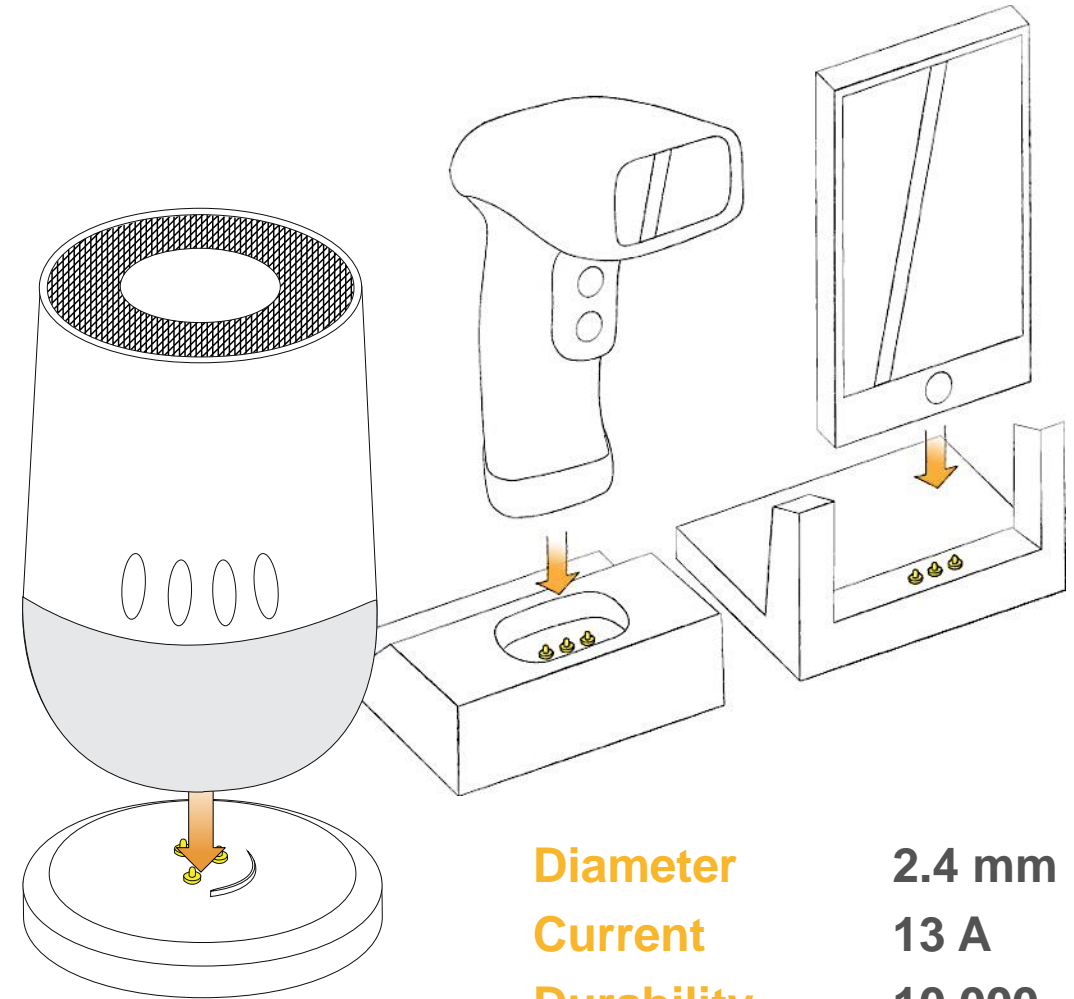

Diameter	2.4 mm
Current	13 A
Durability	10,000
Spring Force	120g ± 20g
Resistance	30 mΩ



Pogo Pin Connector – Docking Module Design

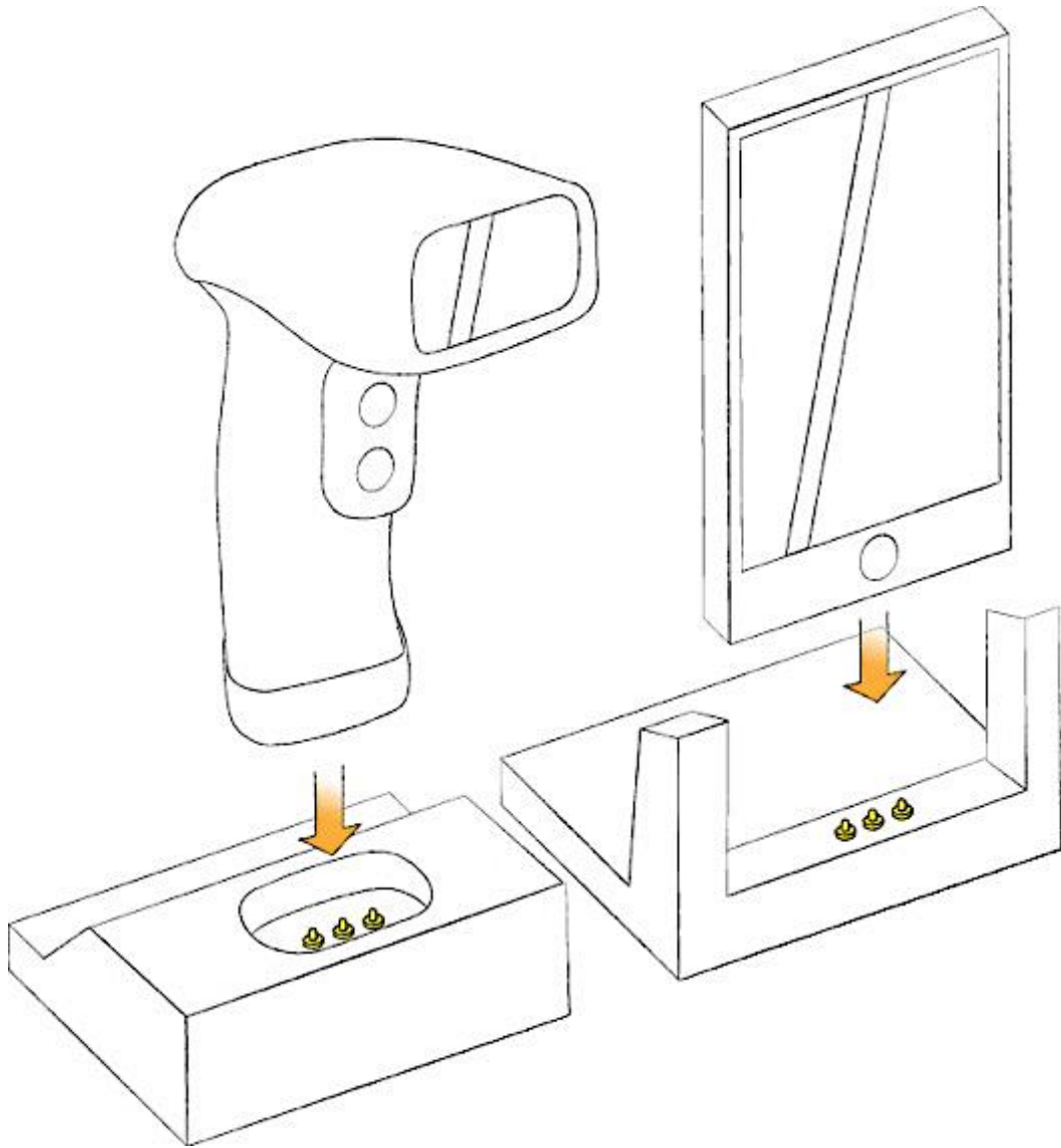

Application

Power Connection
Data Transmission

Advantage

Easy to Contact





Pogo Pin Connector – Ball Point Pogo Pin

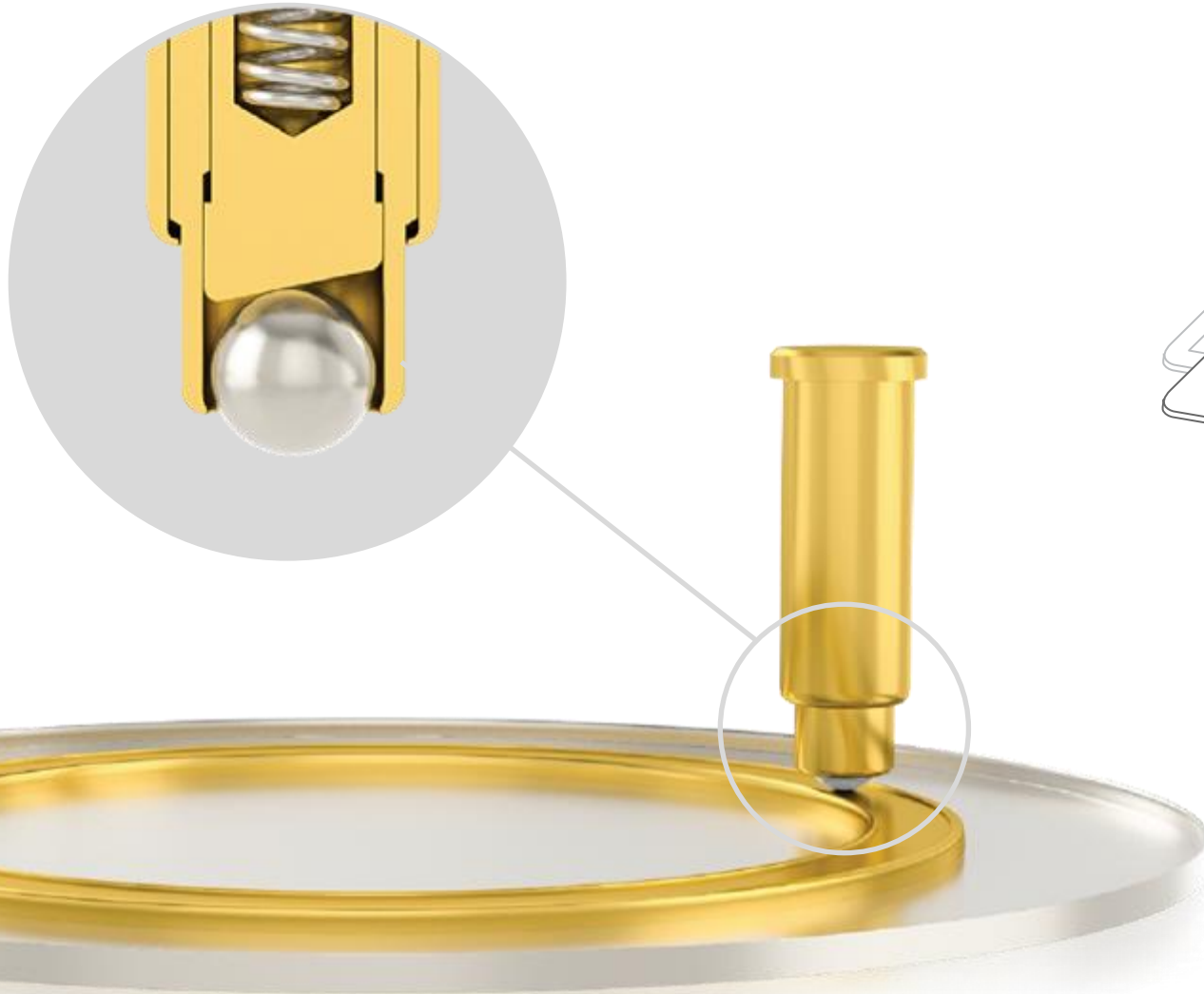

Product Display

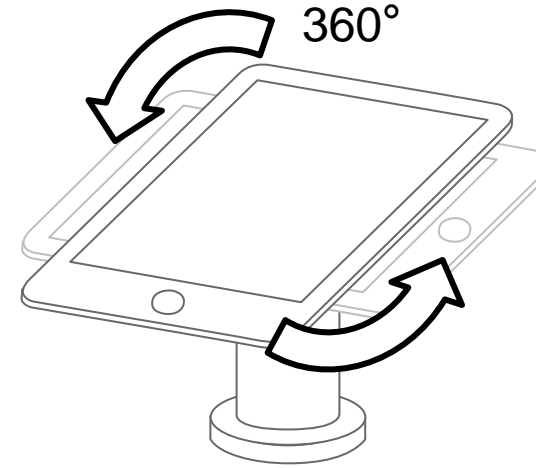

Camera

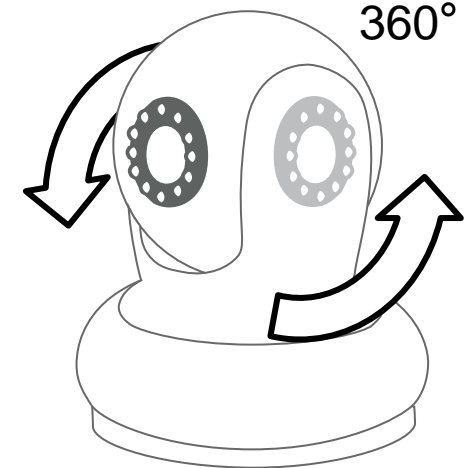

Current	1 ~ 5 A
Durability	10,000
Lateral Movement	25,000,000 mm
Resistance	100 mΩ



Pogo Pin Connector – Rotation Docking Module

Application

Rotation Docking Connection
Hi-speed Data Transmission

Advantage

Customized Shape
Cosmetic Finish
Easy to Connect with Magnet

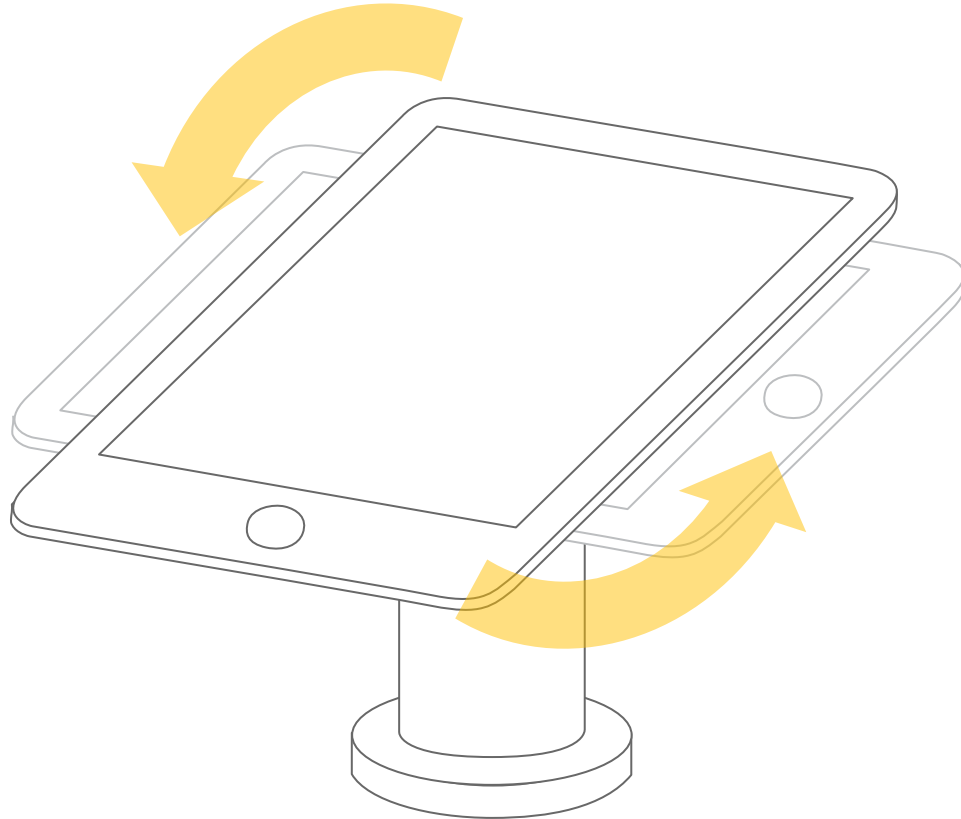



Pogo Pin Connector – High Frequency Connector

Metal Shell

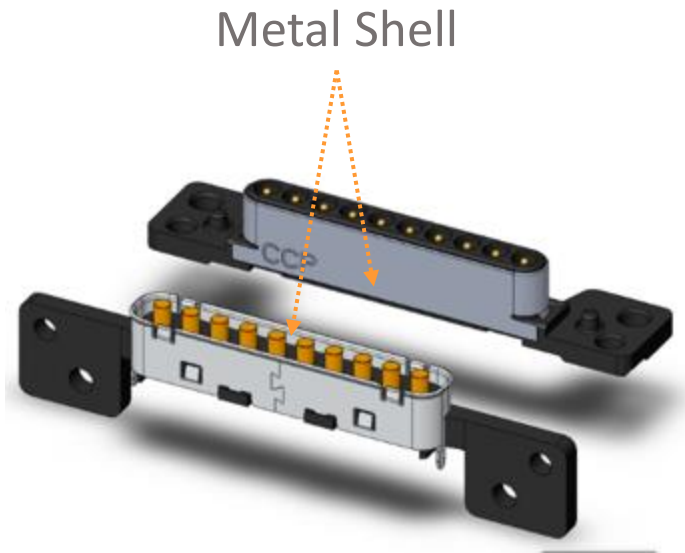

Coaxial

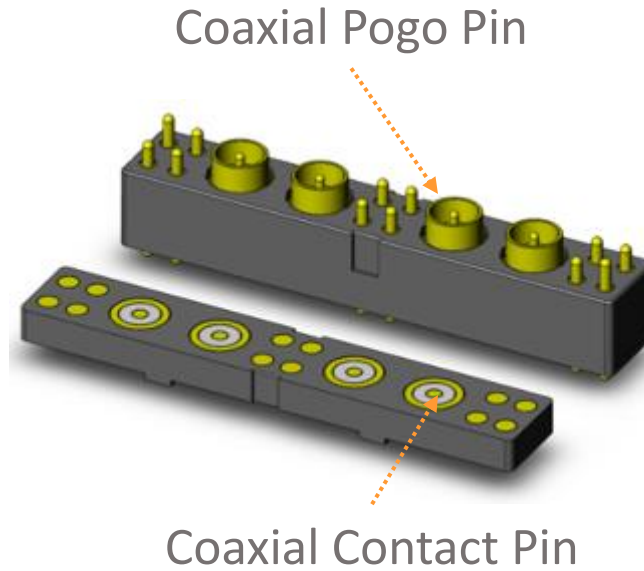

MIM Shell

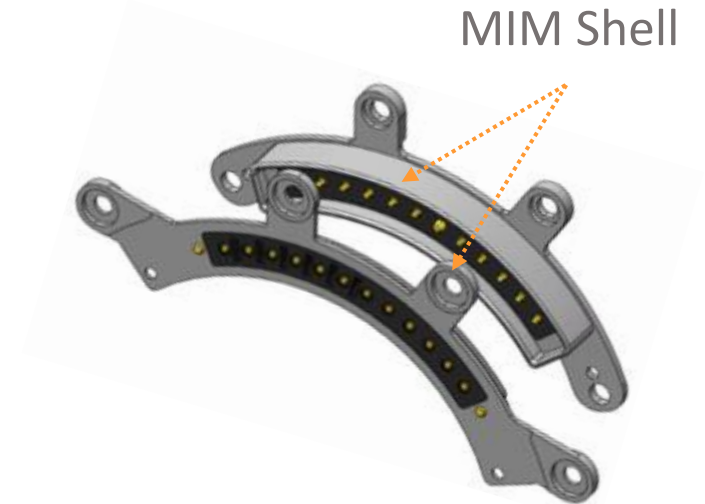



Pogo Pin Connector – High Frequency Application

High Frequency
Magnetic Matting
Desktop Docking



 Mating Area

 Tablet Side Female Connector

 Keyboard Side Male Connector



Pogo Pin Connector – Magnetic Modular Design



Satisfy USB 3.1 Data Transmission
Support Thunderbolt III Data Transmission
Fool-proof via Magnetic Pole
10,000 Life Cycles

Ultra Thin Pogo Pin
High-Speed pins Φ 0.35 mm
Ground Pin Φ 0.50 mm

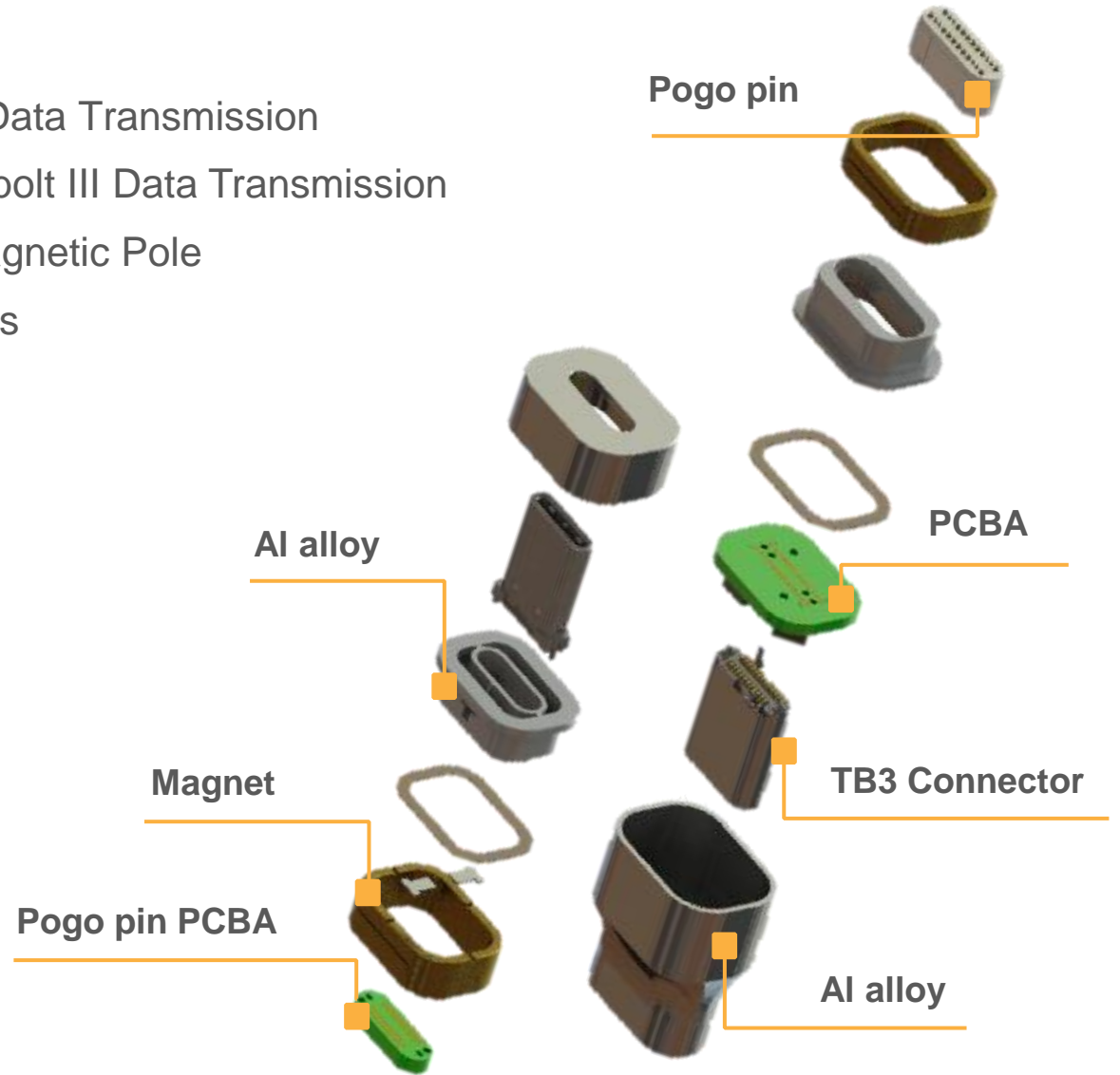



Pogo Pin Connector – Ultra Short Pogo Pin

Developed and designed to fit in compact devices
Feasible for mass production

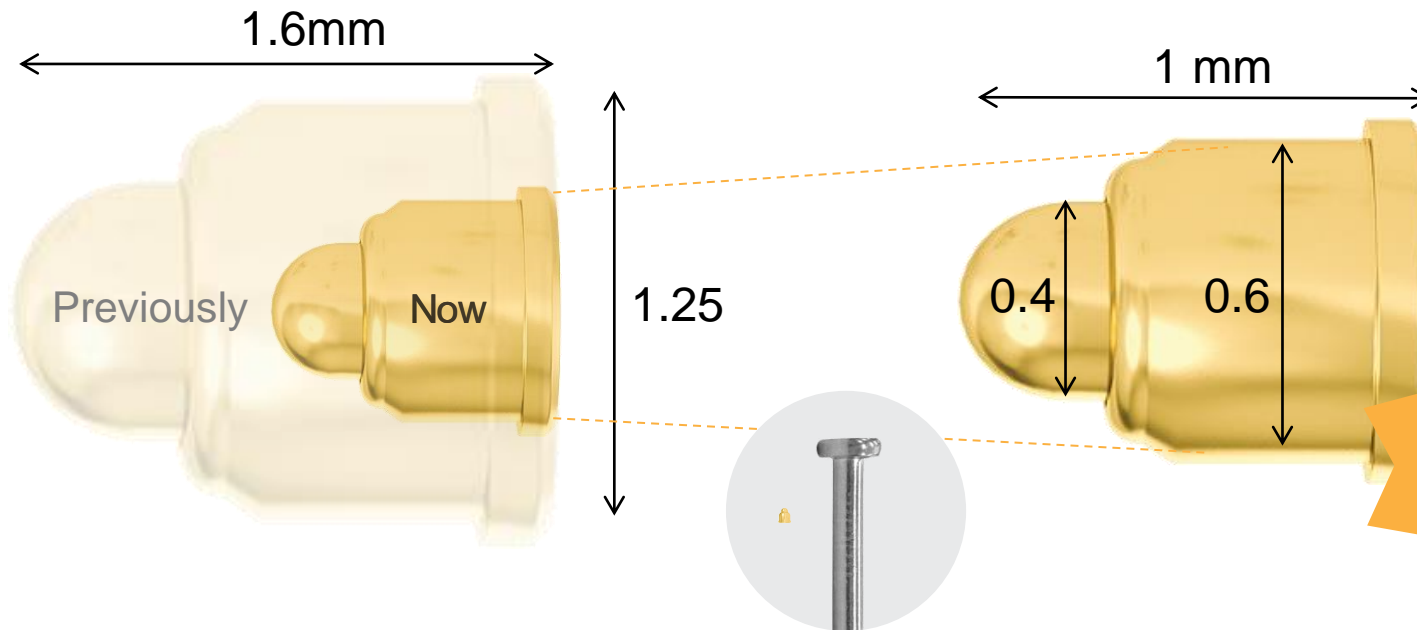
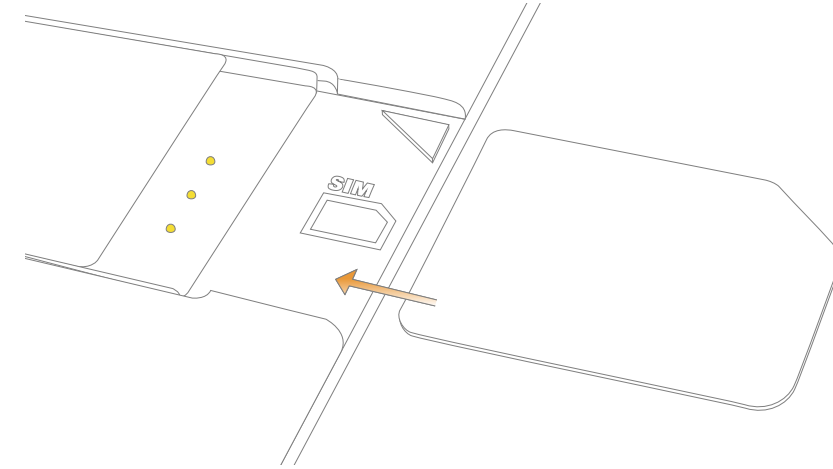

Size:
-60%

Diameter	0.6 mm
Current	1A
Durability	3,000
Spring Force	25 g
Resistance	170 mΩ

Customized for grounding pin purpose



Pogo Pin Connector – Screw Pin

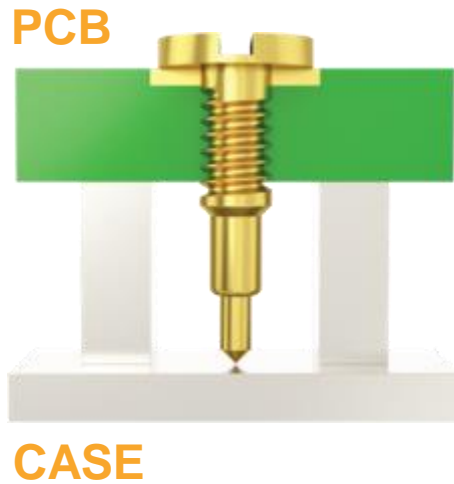
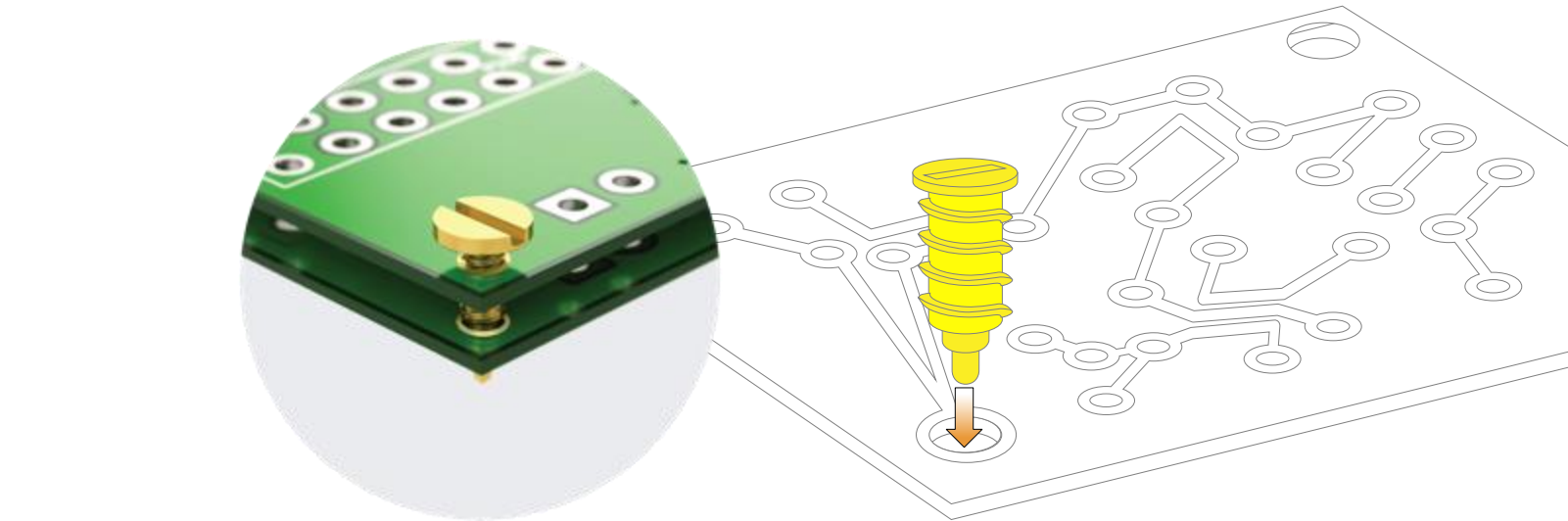
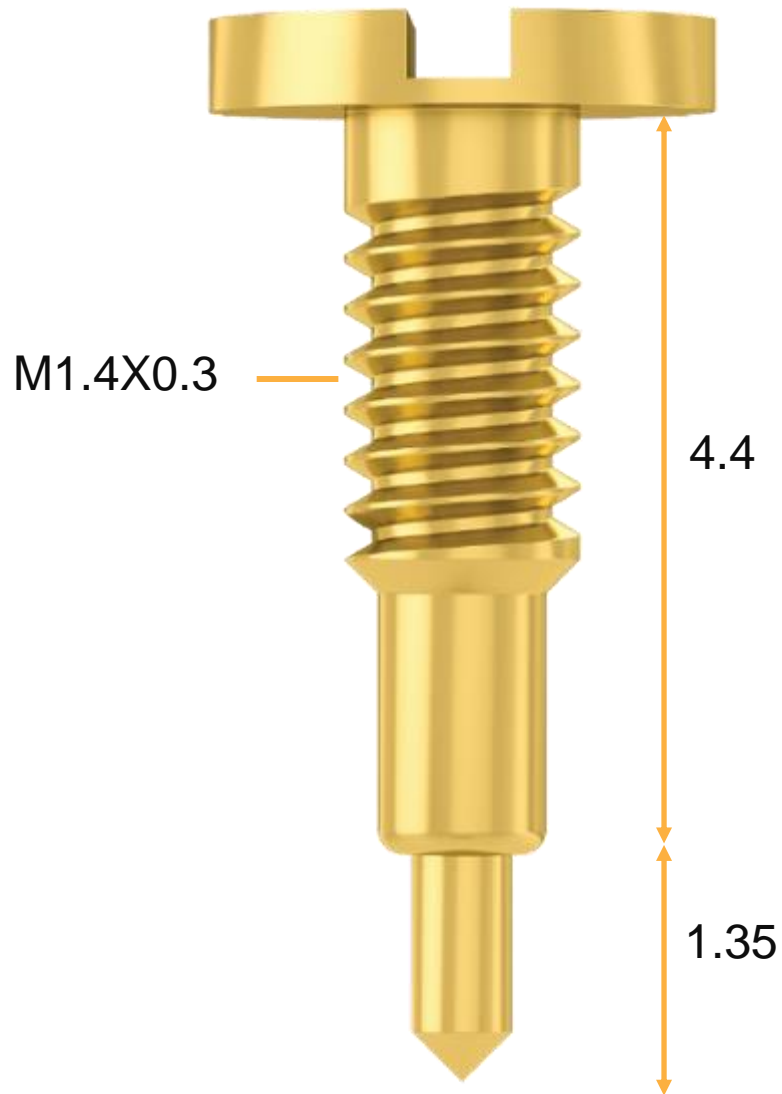

Diameter	3 mm
Current	1 A
Durability	10,000
Spring Force	120g ± 20g
Resistance	200 mΩ
	Customer's Request



Plating Technology – Anti-Electrolysis Plating



**CCP
Super AP**

0 Min



5 Min



10 Min



50 Min



Gold

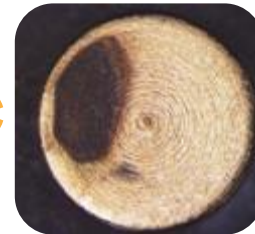
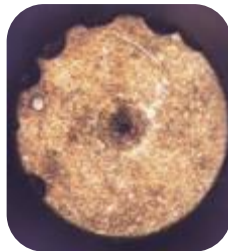



Plating Technology – Electroplating Capability



Plating Development
30 Years Experience
Automated Production Line
Online Plating Monitoring System
Capability: 3,000 Lot/Month

Automatic Degreasing



Function: Degreasing.
Max. Capability: 240 lot/day.
No damage to substrate & no wastewater.

Automatic Pretreatment



Function: Activation.
Max. Capability: 180 lot/day.
High efficiency.

Automatic Post-Treatment



Function: Protection & Cleaning production.
Max. Capability: 240 lot/day.
Consistent Quality

Fischer X-Ray



Function:
Measuring plating thickness.

PE AAS



Function:
Monitor ion concentration.



Plating Technology – Patent Plating Layer



Plating	Testing Standard	Au(50u") Layer	AP Layer	APII Layer	Super AP Layer
Color	/	Gold	Silver	Silver	Silver
Nickel Release	EN 12472:2005+A1:2009	Nickel-containing process	Nickel-free process	Nickel-free process	Nickel-free process
Plating Thickness (micro inch)	XRF	100~170	110-170	270~400	210~400
Resistance (mΩ)	EIA-364-23	< 50	< 50	< 50	< 50
Salt Spray Resistance (HR)	EIA-364-26	96	48	96	168
Artificial Sweat Resistance (HR)	ISO-3160	96	48	96	168
Surface Hardness (HV)	ISO 6507-1:2005	200	400	400	400
Electrolysis Resistance Time	1mA,5V,Pitch=0.60mm	<1min	10min	15min	60min
Cost	Factor to Gold Plating	1	x0.9	x2	x3



Medical Connector Product Line



Critical Care System



Brainwave Headband



Catheter



Endoscope





Medical Connector Product Line

Plug

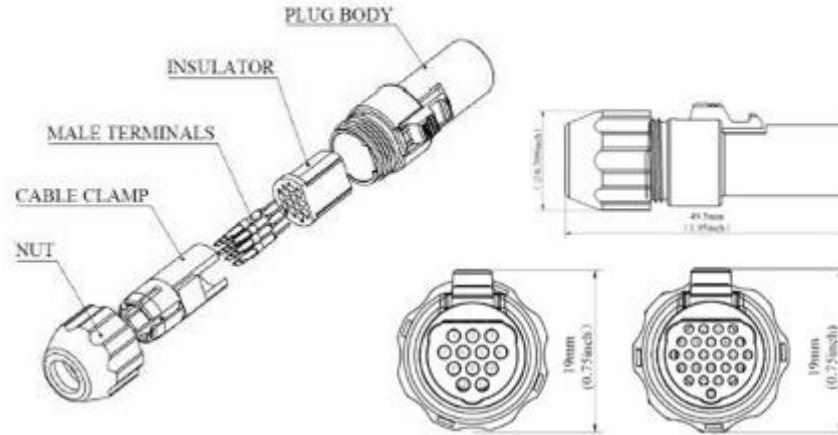

Extremely Low Force
Error Proof Safe Lock
10,000 Life Cycles

Receptacle

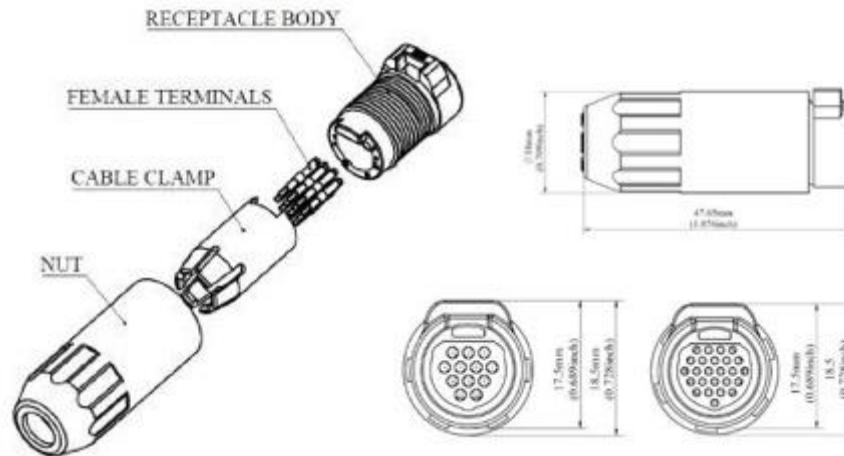



Medical Connector – High Frequency Waterproof

- Application: Medical / Military
- High Speed Transmission
- Customized Size: M8, M10, M12, M16, M18 (Type-C: min. M14)
- Customized Plating Color



Waterproof Level: IP57





Testing Solution Product Line

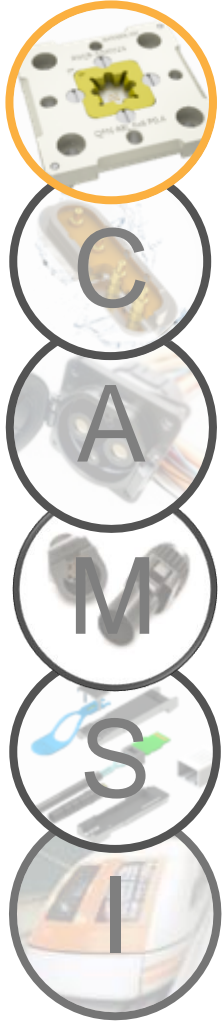

IC Package Test



Burn-In Test



High Frequency Test



Memory Test



WLCSP Test

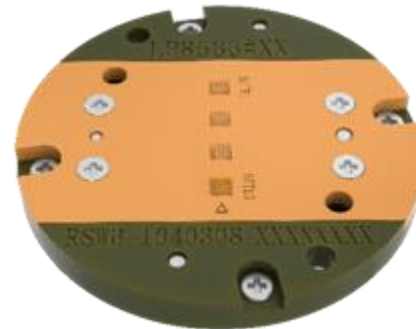

Battery Test





Testing Solution – Testing Probes

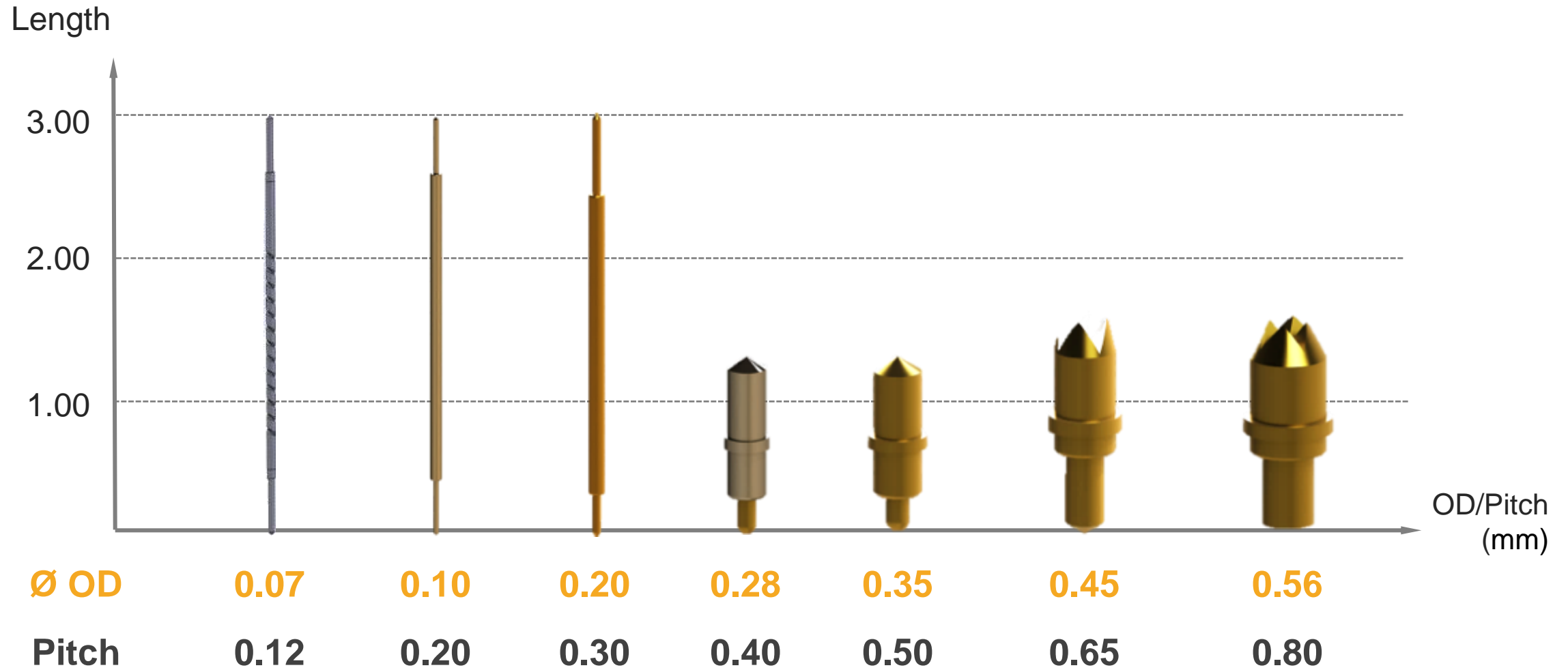



Testing Solution – High Frequency Socket

5G IC

Coaxial Probe Socket

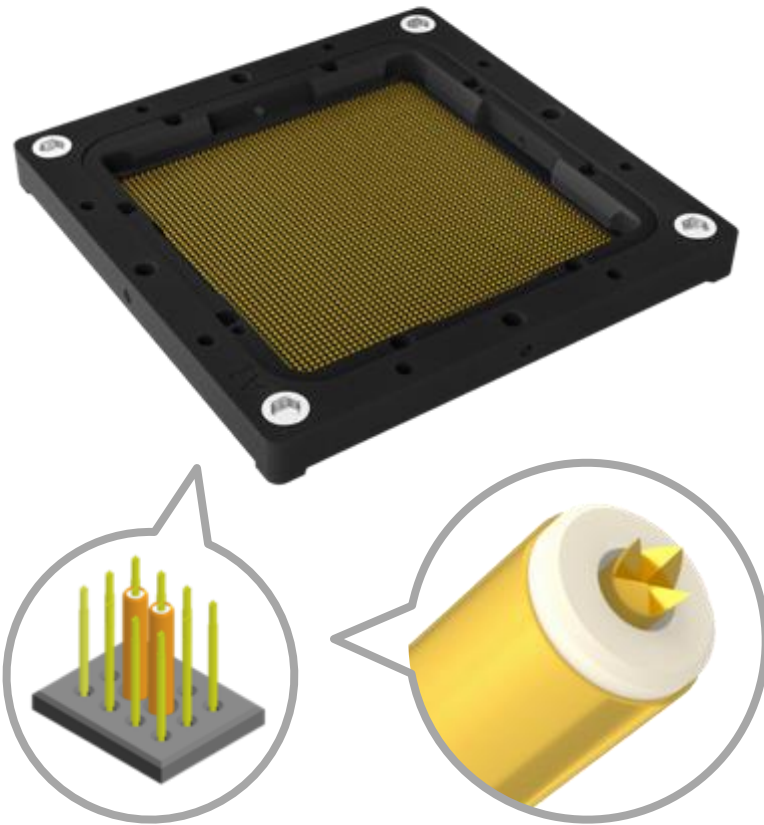

ADAS

Hybrid Coaxial Socket

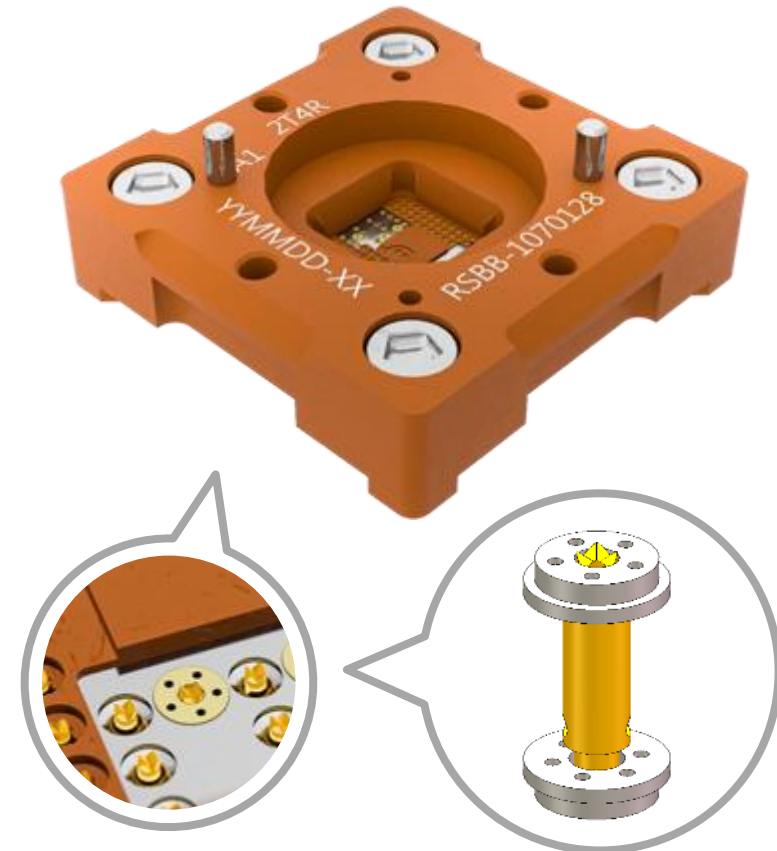



Testing Solution – High Frequency Socket

Unit: -1dB @*GHz

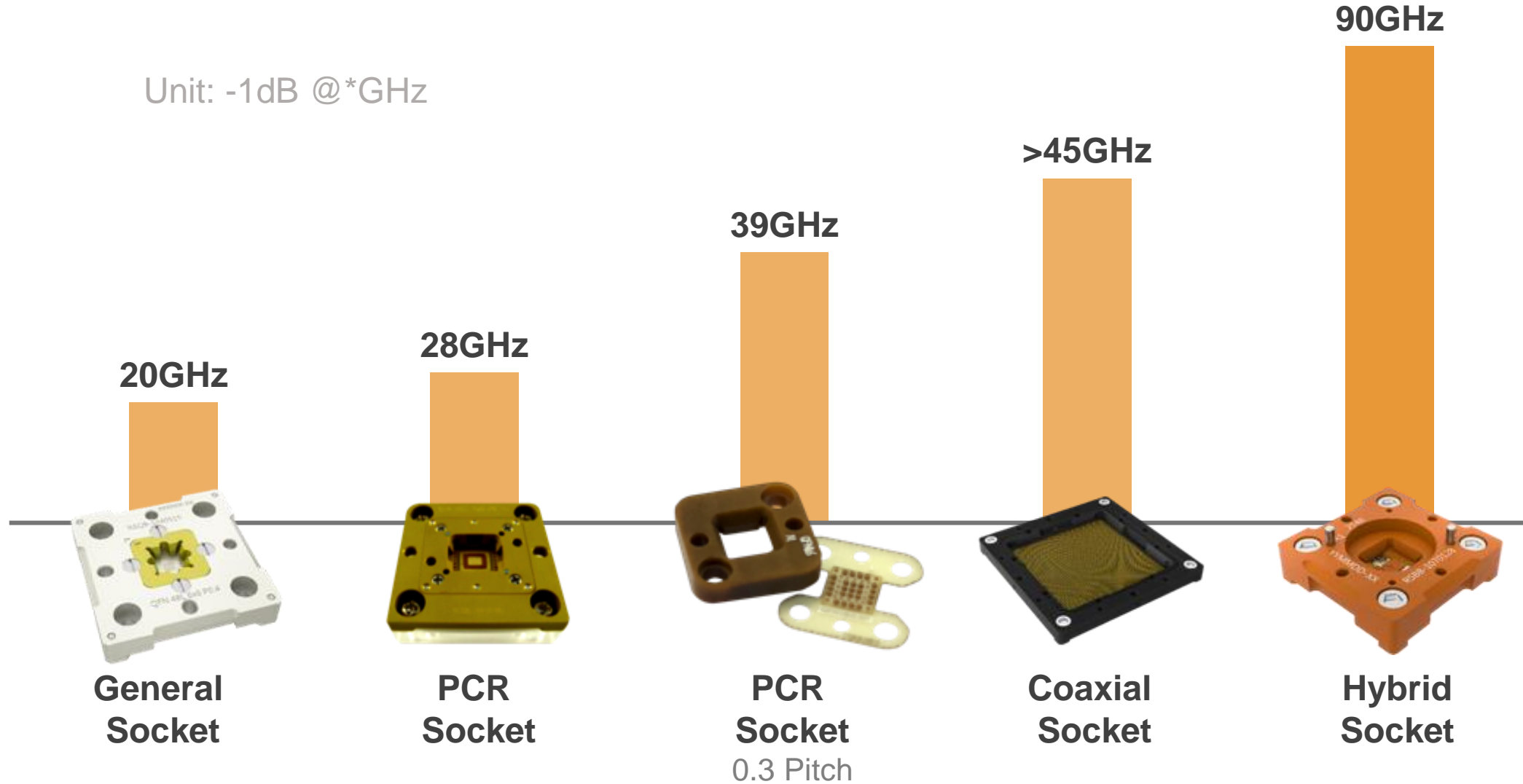



Testing Solution – High Frequency Probes



Ø 0.65mm



Ø 0.54mm



Ø 0.43mm



Ø 0.33mm

Spring Force	30g ± 20% @ 0.40mm	30g ± 20% @ 0.4mm	12~19g ± 20% @ 0.18mm	15g ± 20% @ 0.18mm
Insertion Loss	-1dB>20GHz	-1dB>20GHz	-1dB>20GHz	-1dB>20GHz
Pitch	>0.80mm	0.65mm	0.50mm	0.40mm



Testing Solution – Material Development

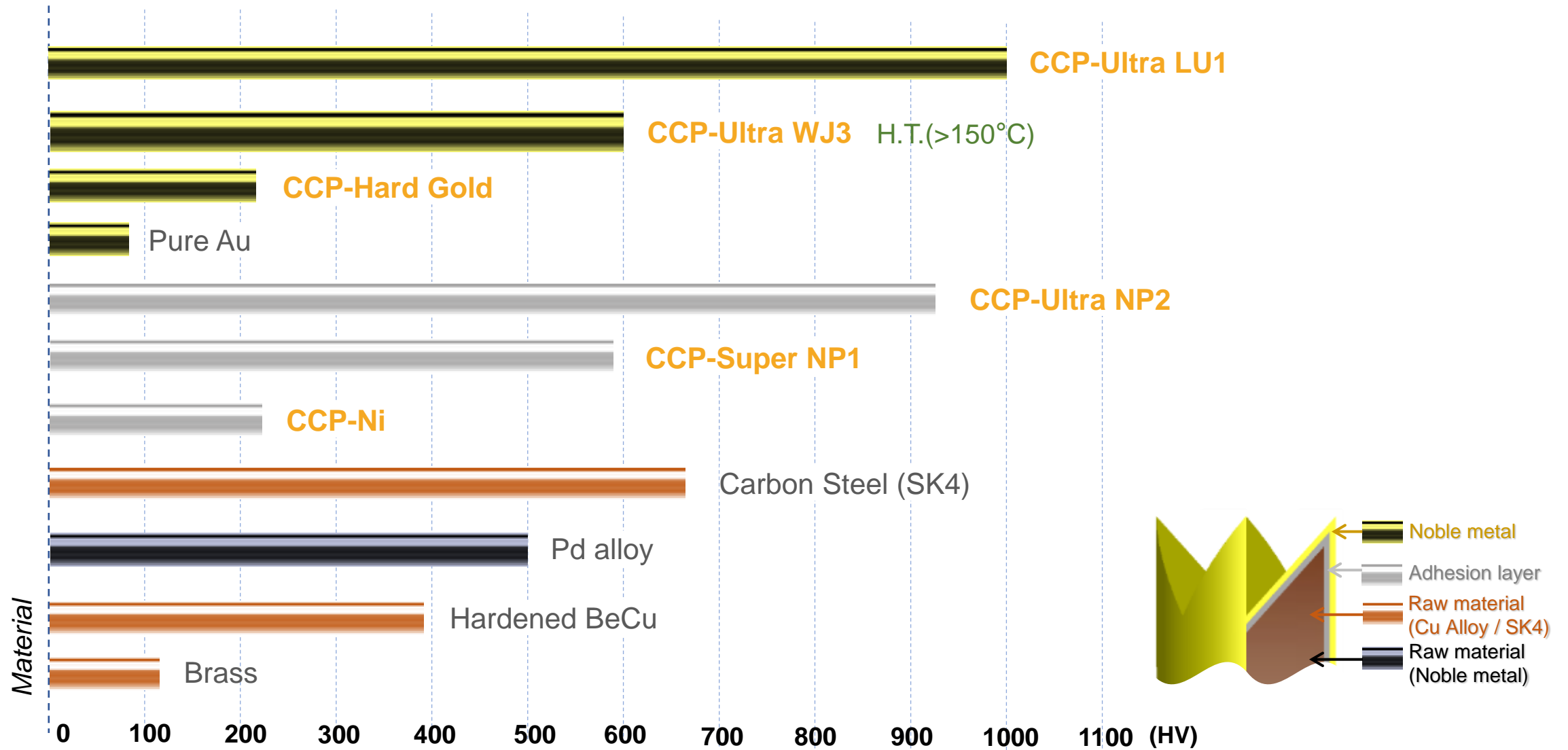



Testing Solution – Integrated Manufacturing



- Automatic CNC lath



- CNC spring coiling machine



- Surface treatment production line



- Semi-automatic assembly machine



- Automatic assembly machine



- Automatic probe **full inspection**





High Current Product Line



EV Charging Station



Scooter Battery System



EV Inner Ports



E-Bike Connector





High Current – Crown Spring Connector

Crown Spring

Copper Alloy with Silver Plating

Min. Size & Max. Contact Points

High Current Up To 600 Amps



Female Terminal

Copper Alloy with Silver Plating

> 20,000 Life Cycles

Low Exertion Force

Male Terminal

Copper Alloy with Silver Plating

Precise Turning Pin

Low Contact Resistance

= Low Temperature Rise

= Low Energy Loss

Patent No: CN 206893841 U



High Current – EV Charging Solution



AC/DC Charging Socket
AC GB/T20234.2 – 2015
16A/32A



GB/T20234.2 – 2015
16A/32A

AC/DC SAE J1772 – 2016
16A/32A/50A/80A/200A

AC/DC IEC 62196 – 2017
16A/32A /200A

UL Certificate E516931
TUV Certificate R50559698





EV Charging Solution - SAE J1772 Charging Gun

Anti Loose
Safety Lock

Logo

High-Strength
**Integrated
Housing Body**

**Crown Spring
Terminal**

Cooper Alloys
Silver Plating

Patent No.
CN 206893841 U

Cable





EV Charging Solution - SAE J1772 Charging Gun



High & Stable Current



Low Temperature Rise



Low Contact Resistance



Safe Design



Long Life Cycle



Flame Retardant



Ergonomic Design



UV Resistance

SPECIFICATION

Mating Cycle	≥ 10000
Insertion Force	$< 100\text{N}$
Current	16A/32A/50A/80A
Voltage	120VAC / 240VAC
Insulation Resistance	$\geq 500\text{M}\Omega$
Flammability Class	UL 94-V0
Operating Temperature	$-30^{\circ}\text{C} \sim +50^{\circ}\text{C}$
Withstanding Voltage	1000V (AC 1 Min.)
IP Rating	IP67



EV Charging Solution - IEC 62196 Charging Gun



Logo

Multi-Texture
Ergonomic Design



Crown Spring
Terminal

Cable

Cooper Alloys
Silver Plating



Patent No.
CN 206893841 U

Plug Color

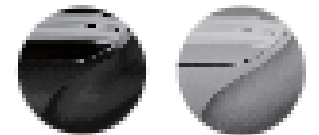



EV Charging Solution - IEC 62196 Charging Gun



High & Stable Current



Low Temperature Rise



Low Contact Resistance



Safe Design



Long Life Cycle



Flame Retardant



Ergonomic Design



UV Resistance



Various Charging Mode

SPECIFICATION

	Single-Phase	Three-Phase
Mating Cycle	≥10000	
Insertion Force	<100N	
Current	16A/ 32A	16A/ 32A
Voltage	250V AC	480V AC
Insulation Resistance	≥500MΩ (500V DC)	
Flammability Class	UL 94-V0	
Operating Temperature	-30°C ~ +50°C	
Withstanding Voltage	1000V (AC 1 Min)	
IP Rating	IP67 (unplugged)	



EV Charging Solution - IEC 62196 Charging Gun



IEC 62196 Portable Charger

IEC 62196 Type 2 to Type 2



EV Charging Solution - CCS Combo 1 Charging Gun

Anti Loose
Safety Lock

Multi-Texture
Ergonomic Design

Logo Label

Crown Spring
Terminal

Cooper Alloys
Silver Plating

Patent No.
CN 206893841 U

Cable

80A / 200A





EV Charging Solution - CCS Combo 1 Charging Gun



High & Stable Current



Low Temperature Rise



Low Contact Resistance



Safe Design



Long Life Cycle



Flame Retardant



Ergonomic Design



UV Resistance



Temperature Monitoring

SPECIFICATION

Mating Cycle	≥ 10000
Insertion Force	$< 100\text{N}$
Current	80A/200A
Voltage	1000V
Insulation Resistance	$\geq 5\text{ M}\Omega$
Flammability Class	UL 94-V0
Operating Temperature	$-30^{\circ}\text{C} \sim +50^{\circ}\text{C}$
Withstanding Voltage	3000V (AC 1 Min.)
IP Rating	TYPE 4



EV Charging Solution - CCS Combo 2 Charging Gun

Multi-Texture
Ergonomic Design





EV Charging Solution - CCS Combo 2 Charging Gun



High & Stable Current



Low Temperature Rise



Low Contact Resistance



Safe Design



Long Life Cycle



Flame Retardant



Ergonomic Design



UV Resistance



Temperature Monitoring

SPECIFICATION

Mating Cycle	≥ 10000
Insertion Force	$< 100\text{N}$
Current	200A
Voltage	1000V
Insulation Resistance	$\geq 5\text{ M}\Omega$
Flammability Class	UL 94-V0
Operating Temperature	$-30^{\circ}\text{C} \sim +50^{\circ}\text{C}$
Withstanding Voltage	3000V (AC 1 Min.)
IP Rating	IP 54



High Current – E-Scooter Connector





High Current – E-Bike Battery Connector



Battery Connector



Battery Charger



High Current – Power Storage Connector

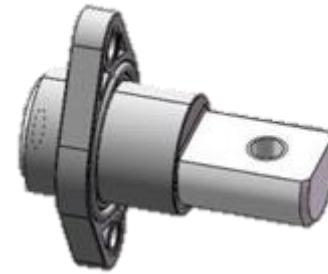

Feed Through Terminal

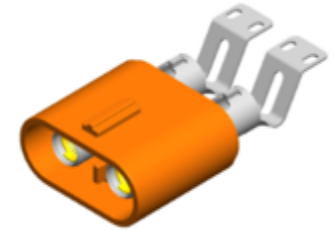

Current Diversion Connector



High Voltage Power Lock Connector

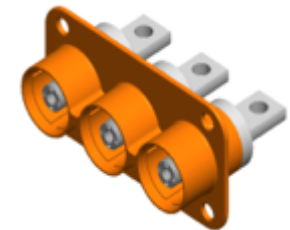

High Voltage Power Lock Module



Manufacturing Capability – Precision Machining



CAM Turret Machine: 105 Units
Capacity: 20KK
Precision: 0.005mm

CNC Turret Machine: 42 Units
Capacity: 2KK
Precision: 0.001mm

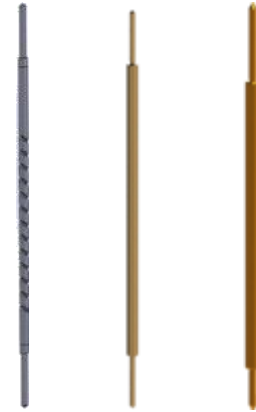

IC Test Probe



Pogo Pin



High Current
Pin & Socket



Customized



Manufacturing Capability – Precision Machining

Factory overview



Turning CAM

CNC



CNC

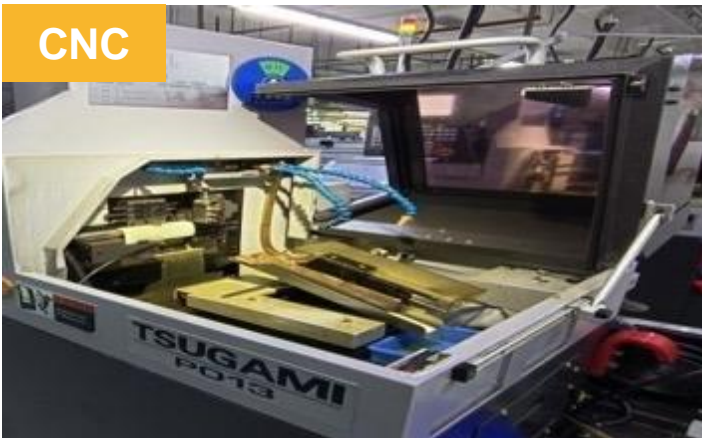

Turning Capacity: 28M/month Cloud Management System

Manage and monitoring labor, machine and material (equipment utilization; yield; production efficiency; equipment TPM management)

Equipment	Accuracy (mm)	Quantity	Capacity (pcs)
CAM	0.005	105	28M
CNC NPI	0.001	14	0.7M
CNC NPI	0.001	33	2.2M

CNC dedicated for NPI can be converted to MP when needed



Manufacturing Capability – Precision Machining

Post Processing



Equipment	Accuracy (mm)	Quantity	Capacity (pcs)
Secondary machine	0.01	98	30KK

Function:

CNC and fine-turning machine

(bias, grooving, thread addendum, drill, deburring etc.)

Heat Treatment



Equipment	Material	Quantity
Quenching furnace	SK4	1
Vacuum Tubular Furnace	BeCuPd Alloy	2
Oven	Pre-processing	1
Vacuum Machine	Pre-processing	1



Manufacturing Capability – Plastic Injection Molding Factory



50T FANUC ROBOSHOT
Injection Molding Machine
Capacity: 3KK pcs / Month



50T-170T TOYO DH300C
Injection Molding Machine
Capacity: 5KK pcs / Month



55T-120T
Injection Molding Machine
Capacity: 3KK pcs / Month



EV Charging Gun
Housing



Insert Molding
High Current
Connector



Manufacturing Capability – Injection Molding

Injection Machine



Injection molding equipment:

- Metal molding equipment: 55T-120T
- Fanuc injection molding machine: 50T
- Toyo injection molding machine: 50T-230T
- MultiTech precision molding machine
- Injection molding processing capacity 6.5kk/month



Manufacturing Capability – Injection Molding

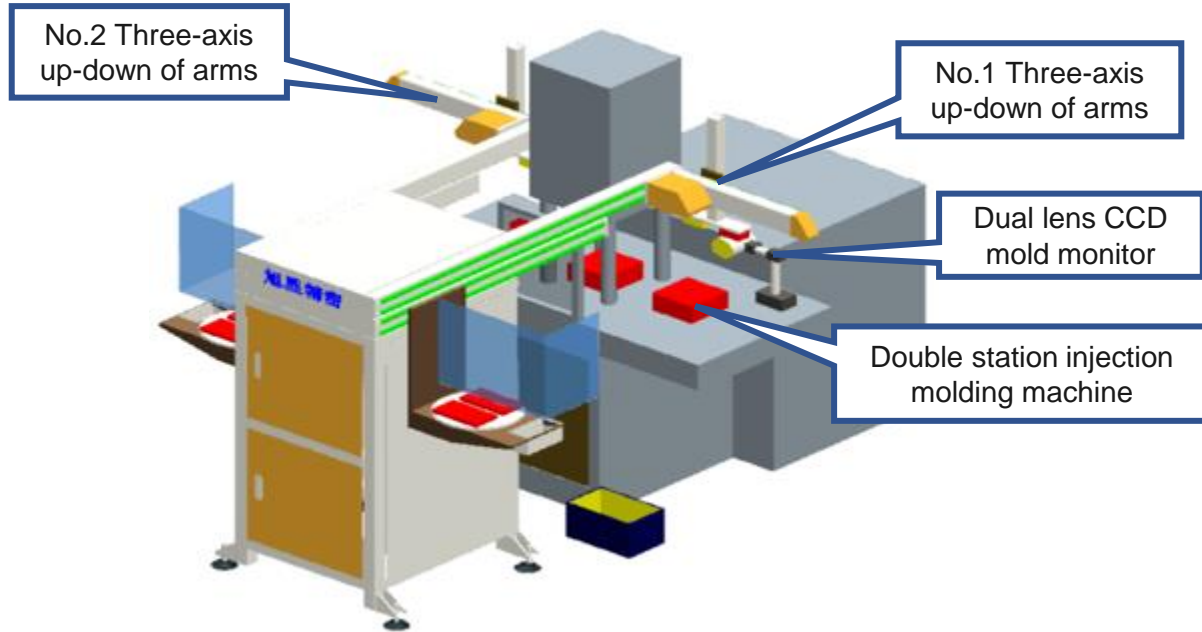

Automatic Molding Process



The instruction of the device:

- Double station loading and unloading equipment adopts two sets of independent systems to control left and right stations, respectively. It can be used independently single or both sides.
- The loading and unloading manipulator of each station is controlled by three-axis servo motor, with accurate positioning and convenient adjustment.
- Effective production line for operation and maintenance.



Manufacturing Capability – Injection Molding

Mold Flow Analysis

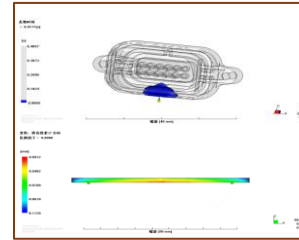
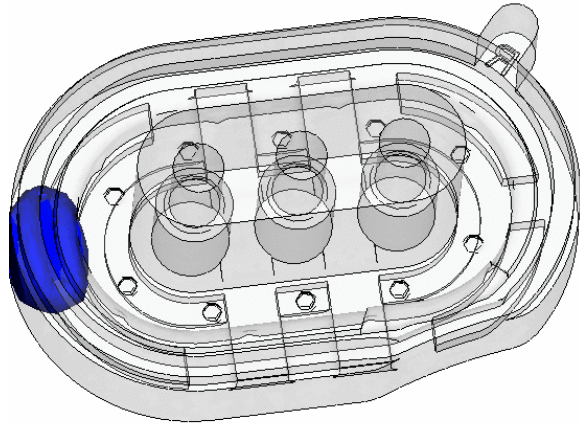

- Tool material and structure R & D capability
- Process development capability
- Fixture development ability
- Analogue simulation
- Molding design
- Molding manufacturing
- Fixture manufacturing
- Injection molding
- Metal injection molding

Tooling Processing



- Molding tool fabricating equipment is equipped with Swiss G + F equipment.
- Mikron machining center, G + F slow wire, Triple mirror spark machine, Fully automatic grinder, Microporous punch
- Molding tool capacity 10 sets / month, Precision Molding $\pm 5 \mu m$
- Tooling type: insert molding, injection molding, stamped tooling



Manufacturing Capability – Stamping Factory

Stamping



Stamping machine 40T-80T

- Stamping Accuracy: $\pm 0.01\text{mm}$
- Stamping speed: 300-800 spm
- Material: ALU, BCP, BSP, PBP, SK4, SUS
- Capability: 1.8B pcs/Month

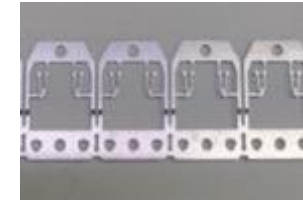
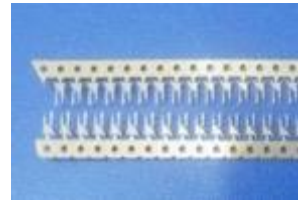



Manufacturing Capability – Assembly

12 Assembly & Test Production Lines

Capacity: Pogo Pin 150KK / month

80% of the process equipment are developed and designed by CCP team, 20% co-develop with customer/supplier

100% assembly lines are developed in-house

Factory overview



Semi Automatic Production Line

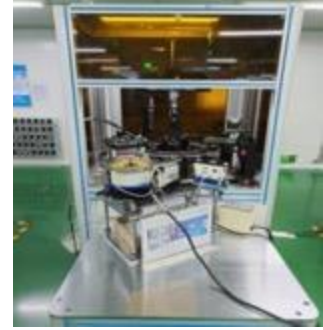
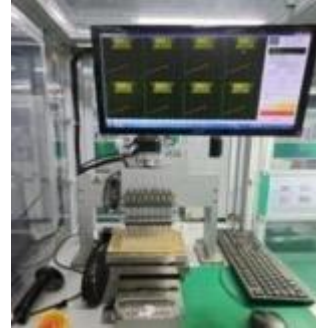

Crimping Machine

- Capacity: 8K/h
- Equipment Accuracy: $\pm 0.01\text{mm}$
- Crimping Accuracy: $\pm 0.02\text{mm}$

Prepressing Machine:

- Prepress: 10K/h
- Equipment Accuracy : $\pm 0.01\text{mm}$
- Pressing Accuracy: $\pm 0.02\text{mm}$

Resistance Measuring:

- Inspection: 6K/h
- Equipment Accuracy: $\pm 0.01\text{mm}$
- Inspection Accuracy: $\pm 0.03\text{m}\Omega$

Spring Force Measuring:

- Inspection: 6aK/h
- Equipment Accuracy: $\pm 0.01\text{mm}$
- Inspection Accuracy: $\pm 0.02\text{g}$

NG Picking Machine:

- Capacity: >8K/h
- Equipment
- Accuracy: $\pm 0.02\text{mm}$

AOI

- Capacity: >8K/h
- Equipment Accuracy: $\pm 0.01\text{mm}$
- Inspection Accuracy: $\pm 0.001\sim 0.015\text{mm}$

Auto/ Semi Packing

- Capacity: >6K/h



Manufacturing Capability – Automatic Product Line



Fully Automatic Production Line

Launched in 2021 Q4 after two years of research and development. Line copying in plan to implement and to replace labor intensive production line.



Auto-Assembly & inspection

- Capability : 20K/h
- Precision: $\pm 0.01\text{mm}$



Auto-Reclaimer

- Precision of counter point: $\pm 0.02\text{mm}$
- Repeatability $\pm 0.01\text{mm}$



Auto-Align Components



Auto-Crimping

- Precision of counter point : $\pm 0.01\text{mm}$
- Precision of crimping: $\pm 0.01\text{mm}$



Resistance inspection

- Precision of testing: $\pm 0.01\text{mm}$
- Precision of the inspecting: $\pm 0.03\text{m}\Omega$



Spring Force Inspection

- Precision of the testing: $\pm 0.01\text{mm}$
- Precision of the inspecting : $\pm 0.02\text{g}$



Manufacturing Capability – Assembly

Crimping



Name	Spec	Accuracy(mm)	QTY	Capacity
Crimping Machine	3-axis, 5PIN	±0.01	25	50kk/month
Single PIN Crimping Machine	XY-axis, cylinder	±0.02	50	40kk/month
Automated Rolling Groove Machine	3-axis auto assembly	±0.01	10	2.6kk/month
Semi - Automated Rolling Groove Machine	Single-axis, 4 cylinder	±0.01	18	2kk/month

Roll-groover



Automated rolling groove and Crimping machines are 100% developed and designed by CCP developed team.



Manufacturing Capability – Assembly

Laser Welding



Equipment	Type/ Spec	Power	Qty
Fiber Laser Marking Machine	Red Light; Air Cooling	20W	3
Fiber Laser Marking Machine	Purple light; Air Cooling	20W	2
Laser Welding Machine	Three-axis	4500W	1

Glue machine



High velocity glue dispensing machine



UV glue potting line



Three-axis dispensing/potting machine



Musashi



Specialized inline system for underfilling, damming and encapsulation.
High speed 2000mm/s
Dispensing pattern auto programming

Equipment	Type/ Spec	Accuracy	Qty
Three-axis Dispensing Machine	Single Glue	±0.5g	10
High Velocity Dispensing Jet Machine	Single Glue	±0.3g	1
Three-Axis Dispensing / Potting Machine	Mix Glue	±0.5g	3
Air Leakage Testing Machine	Air Leakage Testing	6KPa	4
Auto Air Leakage Testing Machine	Air Leakage Testing	6KPa	1



Manufacturing Capability – Inspection

AOI



Defect inspect AOI



AOI Deep Learning

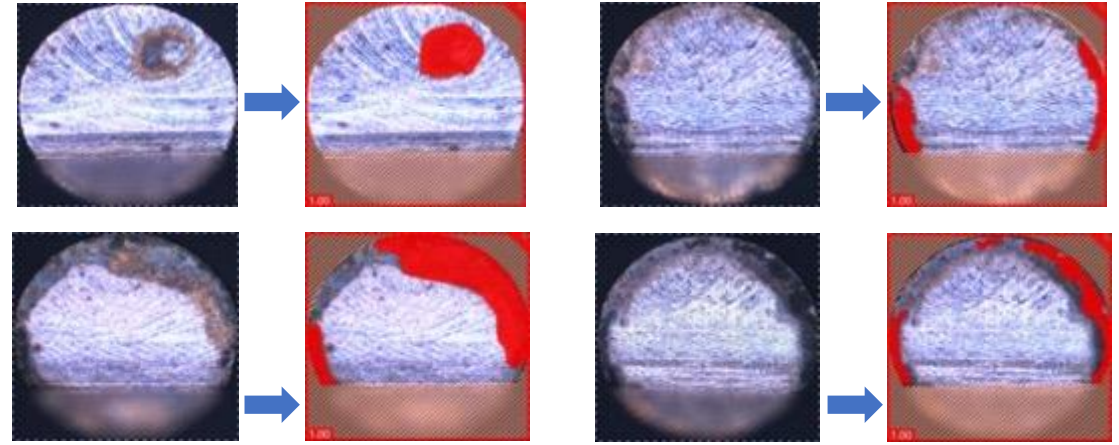

30+ CCD inspection equipment have been invested for quality inspection of product dimension and appearance defects, which cover wide inspection requirements.

In 2021, CCP has developed, customized, and implemented AOI on the production floor successfully for high-quality requirements.

1. Vision Pro system for product positioning and image segmenting.
2. Deep learning algorithm to extract defect regions.
3. Judge OK / NG through the extracted defect area.

AOI Device List				
Equipment	Type/ Spec	Precision	Qty	Detectability
AOI	For all product	0.015	6	6k/h
AOI	For non-standard product	0.01	19	6~8Kh
DL AOI	Appearance defect inspection	0.01	6	10k/h



Manufacturing Capability – Packing

AOI Packing Machine



Plate Auto-Packing Machine



Manual Packing Machine



Auto Vibration-Disk Packing Machine



Each production area has packing machine set up ready to meet customer's requirements.

Packing Equipment List

Equipment	Function	Qty
Auto-Inspected and packing machine	Dimension inspection + Auto-packing	5
Auto vibration-disk packing machine	Automatic suction packing	8
Plate auto-packing machine	Automatic suction packing	3
Manual packing machine	Manual packing	8



Testing Capability – CNAS Lab Center

ISO 17025



2018

CNAS Certification

2019

Renewed Certification

50+

Testing Equipment



Testing Capability – Advanced Equipment

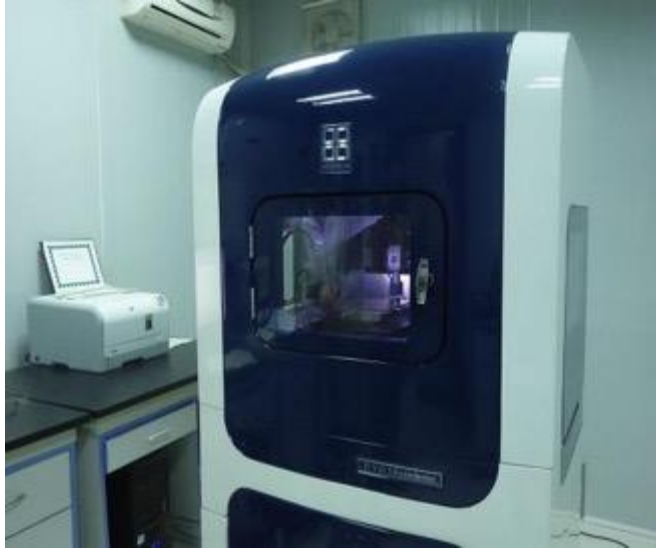

Equipment	Nano indenter
Test item	Measuring film hardness
Force sensitivity	< 30 nN
Manufacturer	Hysitron T950
Origin	USA

Equipment	Scanning electron microscope (SEM)
Test item	Surface morphology, Composition
Detection range	Max. magnification: 800 k X
Manufacturer	Hitachi S-4800
Origin	Japan

Equipment	Scanning electron microscope (SEM)
Test item	Surface morphology, Composition
Detection range	Max. magnification: 300 k X
Manufacturer	Hitachi SU-3500
Origin	Japan



Testing Capability – Advanced Equipment



Equipment	ICP-OES
Test item	Monitor ion concentration.
Measurement limit	Cu:0.7ppb
Wavelength range	160nm-800nm
Manufacturer	GBC
Origin	Australia



Equipment	3 coordinate measuring machine
Test item	Geometric tolerance
Detection range	X = 300 mm, Y = 200 mm, Z = 200 mm
Accuracy	0.01 mm
Manufacturer	ZEISS
Origin	Germany



Equipment	White Light Interferometers
Test item	Measurement the sample roughness
Detection range	600 um*200 um
Accuracy	0.001 um
Manufacturer	Bruker
Origin	Germany



Testing Capability – Test Equipment

Electrical Performance



Network Analyzer



VNA (Vector Network Analyzer)



High Current Power Supply & Electronic Load



Contact Resistance Tester



RCA Tape Abrasion Tester

Mechanical Performance



Safety Comprehensive Analyzer



Mechanical Vibration/Shock

Environmental Testing



Oven



Waterproof test machine



Flush test chamber

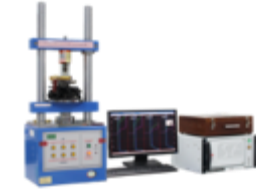

Automatic Insertion Force Tester



Durability Cycling Machine



Thermal shock test machine



Salt spray test machine



Temperature & humidity test machine

Other



Hot-Air Reflow machine



3D laser scanning microscope



X-ray



Electrochemical workstation



Terminal cross section analyzer

Quality Management

Quality System

ISO 9001:2015

Quality Management Systems

IATF 16949:2016

Automotive Quality Management System

ISO 14001 : 2015

Environment Management Systems

QC 080000

Hazardous Substance Process Management

ISO 13485:2016

Medical Devices Quality Management Systems

Quality Assurance



Verification Ability

Testing Items

Environmental

Waterproof

Humidity Test

Salt Spray

Thermal Impact

Resist. to Solder Heat

Vibration

Electrical

Contact Resistance

Insulation

HIPOT

Rated Current

Mechanical

Retention Force

Life Cycle

Vibration

Mechanical Shock

Other

Drop

Soldering Side Force

Solderability

Testing Equipment

Rated Current

Max Rating : 1000Amp



Waterproof

Test Level : IPX7 Up



Thermal Impact

Range : -60~120°C

Resolution : 0.01°C

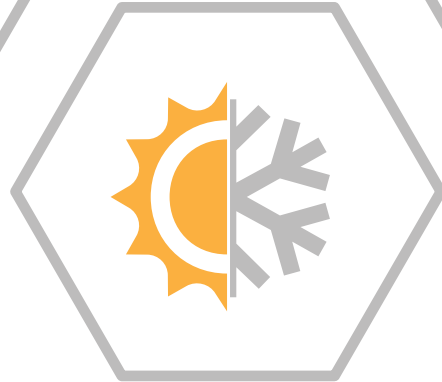

Vibration

Frequency : 3500Hz Max.

Acceleration : 50G Max.





Social Responsibility

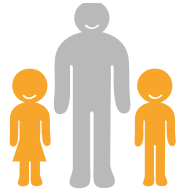

Summer camp for employees' children



Home visit to employees around the world



CCP offers tuition scholarship for employees' children

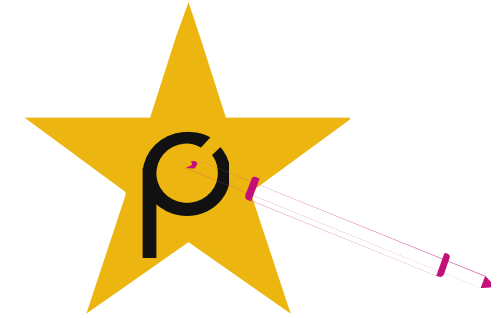
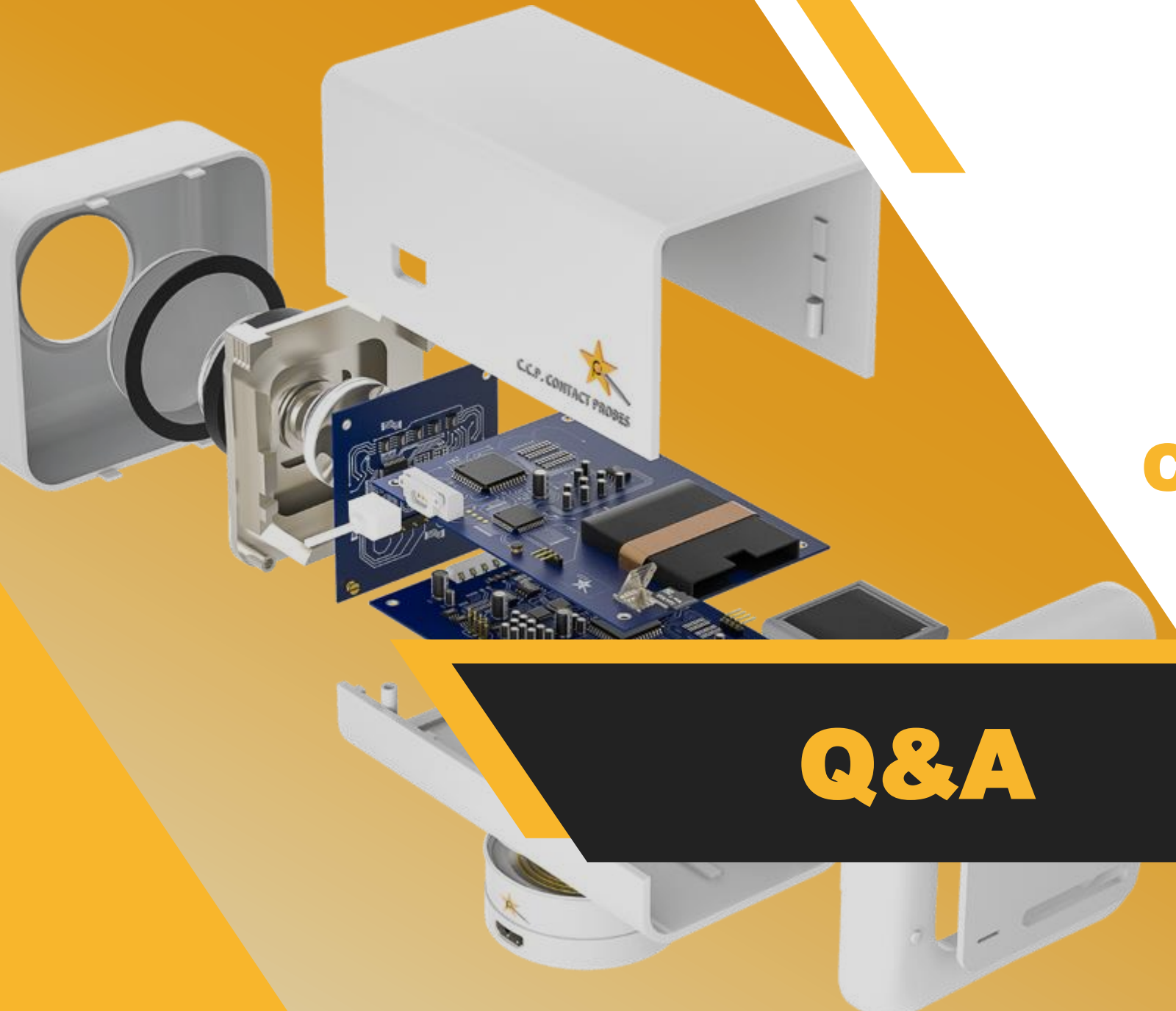

CCP Contact Probes

Q&A

info@pccp.com.tw
www.ccpccontactprobes.com

